

**Medtronic**

Engineering the extraordinary

# ENT product catalog

2023



# Medtronic

Engineering the extraordinary

ENT product catalog

# Directory

# Terms and conditions

Toll free phone 800-874-5797

Toll free fax 800-678-3995

[medtronicent.com](http://medtronicent.com)

## Payment terms and prices

**Payment terms are net 30 days from date of invoice.** Prices do not include any applicable federal, state, or other taxes and will be added to the invoice unless an exemption certificate is supplied. Prices are subject to change at Medtronic ENT's discretion without notice.

## Shipments

FOB, Jacksonville, FL, USA. Freight is prepaid and added to invoice. Date of shipment is based on best estimates using commercially reasonable efforts to ship on schedule. Medtronic ENT shall not be liable for damage or loss due to any delay in delivering. Partial shipments will be made as required. Claims for short shipment are to be made within 10 days of shipment. Claims for goods damaged in shipment are to be made to the delivery carrier. Do not accept damaged shipments unless noted on the Bill of Lading at time of receipt. Medtronic ENT shall not be liable for any failure or delay in delivery occasioned in whole or in part by strikes, lockouts, fire, inability to obtain materials or shipping space, wars, civil commotion, destruction of plants, delay of carriers, any governmental act or regulation, or any other cause beyond its control.

## Warranty

All merchandise shall be covered by the Medtronic ENT standard limited warranty applicable to that product.

**Medtronic ENT specifically disclaims all other warranties, including, without limitation, those of merchantability and fitness for a particular purpose.**

## Product specifications and availability

Specifications, designs, prices, and availability are subject to change. Medtronic ENT reserves the right to discontinue merchandise or to change specifications without notice or obligation.

## Complaint handling

If you encounter a problem or complaint, please: 1) obtain all relevant facts, including name of user, address, phone number, merchandise number, lot/serial number, date of occurrence, and description of circumstances or nature of problem; and 2) report information immediately to Medtronic ENT, Customer Service at the above phone number. Every effort will be made to address and resolve problems in a manner consistent with our goal of providing quality merchandise and services.

## Returned goods

No merchandise may be returned without the prior authorization of Medtronic ENT. To request a returned goods authorization number (RGA) please contact Customer Service with the following information on the merchandise to be returned: 1) the original invoice number or purchase order number; 2) the reason for return; 3) the catalog number; 4) the quantity; and 5) the lot. Please display the RGA number prominently on the box and include it on all paperwork. All authorized returns must be sent freight prepaid.

- A. All returned merchandise must be in its original package. Any merchandise returned that is obsolete, beyond its expiration date, defaced, altered, damaged or has come in contact with body tissue or fluids will not be eligible for return or credit. Sterile merchandise must be returned in full-box quantities with the outer seals intact.
- B. All merchandise (except battery-powered devices) returned unused within 45 days of date of shipment will be credited at customer's purchase price. Battery-powered devices returned within 45 days of date of purchase will be charged a thirty percent (30%) restocking fee.  
All merchandise returned unused after 45 days and up to 90 days from date of shipment will be credited at customer's purchase price less a fifty percent (50%) restocking fee. Merchandise returned more than 90 days from date of shipment is not eligible for return or credit.
- C. Merchandise returned without prior authorization or not in accordance with A and B above will be returned to customer at customer's expense.

# Terms and conditions

## **Return of product for repair**

To arrange for the return of merchandise for repair, call Customer Service at 800-874-5797 to obtain a Return Goods Authorization number (RGA) and to schedule the repair. Please have the original invoice number or purchase order number available to assist in verifying warranty information.

A purchase order number is required to process all repairs. After obtaining an RGA, customer service will inform you of the repair charge that will be billed against your purchase order.

The RGA number should be prominently displayed on the box and included on all paperwork enclosed with the repair. Merchandise returned for repair should be safely packaged in protective wrapping. Customer must include, with the returned merchandise the 1) purchase order number; 2) correct shipping and billing address; and 3) Repair Order Form or statement of problem/reason for repair.

All repairs should be shipped freight prepaid to:

Medtronic Xomed, Inc.  
4102 Southpoint Boulevard  
Jacksonville, FL 32216  
ATTN: RGA # \_\_\_\_\_

## **Important**

Due to the potential threat to health, all instruments and devices returned for repair must have been decontaminated and/or sterilized. Any product received in an unsanitary condition will be deemed unrepairable and discarded unless Medtronic ENT is able to sterilize or decontaminate the product. An additional service fee of \$250.00 will be applied to the cost of the repair of any product requiring sterilization or decontamination by Medtronic ENT.

## **Loaner policy for repairs**

Loaners for merchandise that is being repaired under warranty are provided at no charge and must be returned to Medtronic ENT within ten (10) days after customer's receipt of repaired merchandise. If the loaner is not returned within the allotted time frame, Medtronic ENT reserves the right to charge a daily rental fee. Rental fees will continue to be charged until the loaner is returned to Medtronic ENT.

Customer is responsible for any damage to loaner equipment while in customer's possession or during shipping back to Medtronic ENT. Customer shipping charges associated with the loaner's return.

## **Repair warranties**

All repairs are warranted to be free of defects in material and workmanship for ninety (90) days after the date of shipment.

## **Changes to terms**

**Medtronic ENT retains the right to change any of these terms or conditions without notice.**

# Table of contents

<b>Catalog directory</b> .....	<b>2</b>
Measurements, standards, and conversions.....	7
<b>Office-based solutions</b> .....	<b>8</b>
XPS Nexus™ ENT power console.....	9
StraightShot™ M4/M5 microdebrider handpieces.....	9
StealthStation FlexENT™ navigation system.....	10
NuVent™ EM sinus dilation system.....	10
NuVent™ Eustachian tube dilation balloon.....	11
HydroCleanse™ sinus wash delivery system.....	11
Novapak™ nasal sinus packing and stent.....	11
PROPEL™ family of sinus implants.....	11
SINUVA™ (mometasone furoate) sinus implant.....	11
<b>Powered surgical equipment</b> .....	<b>13</b>
Powered ENT system and components, IPC™.....	14
Powered ENT system and components, XPS Nexus™.....	15
Powered ENT system and components, microdebriders.....	16
Powered ENT system and components, Hydrodebrider™.....	17
30K burs for the StraightShot™ M4 and M5.....	18
Automated EM tracking blades for the StraightShot™ M4/M5 rotatable.....	19
Quadcut™ blades for the StraightShot™ M4 and M5.....	20
Straight sinus blades, m4 rotatable.....	21
Curved sinus blades, m4 rotatable.....	23
Curved sinus blades, non-rotatable.....	24
Straight sinus burs.....	25
Straight sinus bur accessories.....	26
Curved sinus burs, anterior skull base.....	27
Curved sinus burs.....	28
Tonsillectomy and adenoidectomy blades.....	29
Airway blades, m4 rotatable.....	30
Airway blades, non-rotatable.....	32
<b>Endoscopy products</b> .....	<b>34</b>
ENT Slide-On™ EndoSheath™ system.....	35
Endoscopes.....	37
Endo-Scrub™ 2 lens cleaning system.....	38
<b>ENT navigation solutions</b> .....	<b>39</b>
StealthStation™ ENT navigation system.....	40
StealthStation FlexENT™ navigation system.....	40
<b>Nerve monitoring equipment</b> .....	<b>44</b>
NIM Vital™ nerve monitoring system.....	45
NIM-Neuro™ 3.0.....	46
EMG endotracheal tubes.....	47
Probes: monopolar stimulating.....	48
Probes: bipolar stimulating.....	49
Other disposables.....	50
Electrodes: recording.....	51
Nerve locators/stimulators.....	53

# Table of contents

<b>Parathyroid detection equipment</b> .....	<b>54</b>
PTeye™ parathyroid detection system.....	55
<b>Ventilation tubes and myringotomy accessories</b> .....	<b>56</b>
Ventilation tubes and myringotomy accessories .....	57
Ventilation tubes: temporary.....	58
Ventilation tubes: permanent and specialty .....	67
<b>Ossicular reconstruction implants and accessories</b> .....	<b>68</b>
Stapedectomy/stapedotomy implants: pistons .....	69
Stapedectomy/stapedotomy implants: cupped pistons.....	73
Universal ossicular reconstruction implants: titanium .....	75
Partial ossicular reconstruction implants: titanium.....	76
Partial ossicular reconstruction implants: dense hydroxylapatite.....	77
Partial ossicular reconstruction implants: Flex H/A.....	79
Partial ossicular reconstruction implants: Flex H/A™ Necrosis .....	82
Partial ossicular reconstruction implants: H/A combination.....	83
Partial ossicular reconstruction implants: Polycel™ .....	84
Total ossicular reconstruction implants: dense hydroxylapatite .....	85
Total ossicular reconstruction implants: H/A combination .....	87
Total ossicular reconstruction implants: Flex H/A.....	88
Total ossicular reconstruction implants: Polycel™.....	91
Universal ossicular reconstruction implants: Flex H/A .....	92
Middle ear liners.....	93
Middle ear specialty instruments .....	94
Head supports.....	95
<b>Localized drug delivery</b> .....	<b>96</b>
PROPEL™ family of sinus implants .....	97
SINUVA™ (mometasone furoate) sinus implant .....	97
<b>Tissue health</b> .....	<b>99</b>
Postoperative dressing.....	100
Otologic products .....	101
Nasal packing.....	102
Sinus packing .....	104
Ear wicks and packs .....	105
Epistaxis treatment products .....	106
Splints .....	107
Septal buttons .....	110
Other products .....	111

# Measurements, standards, and conversions

## Millimeter equivalents

MM = INCHES	MM = INCHES	MM = INCHES
.1= .00384	29.0 = 1.14173	65.0 = 2.55905
.2= .00787	30.0 = 1.18110	66.0 = 2.59842
.3= .01181	31.0 = 1.22047	67.0 = 2.63779
.4= .01575	32.0 = 1.25984	68.0 = 2.67716
.5= .01968	33.0 = 1.29921	69.0 = 2.71653
.6= .02362	34.0 = 1.33858	70.0 = 2.75590
.7= .02756	35.0 = 1.37795	71.0 = 2.79527
.8= .03149	36.0 = 1.41732	72.0 = 2.83464
.9= .03543	37.0 = 1.45669	73.0 = 2.87401
1.0 = .03937	38.0 = 1.49606	74.0 = 2.91338
2.0 = .07874	38.1 = 1.5	75.0 = 2.95275
3.0 = .11811	39.0 = 1.53543	76.0 = 2.99212
4.0 = .15748	40.0 = 1.57480	76.2 = 3.0
5.0 = .19685	41.0 = 1.61417	77.0 = 3.03149
6.0 = .23622	42.0 = 1.65354	78.0 = 3.07056
7.0 = .27559	43.0 = 1.69291	79.0 = 3.11023
8.0 = .31496	44.0 = 1.73228	80.0 = 3.14960
9.0 = .35433	45.0 = 1.77165	81.0 = 3.18897
10.0 = .39370	46.0 = 1.81102	82.0 = 3.22834
11.0 = .43307	47.0 = 1.85039	83.0 = 3.26771
12.0 = .47244	48.0 = 1.88976	84.0 = 3.30708
12.7 = .5	49.0 = 1.92913	85.0 = 3.34645
13.0 = .51181	50.0 = 1.93500	86.0 = 3.38582
14.0 = .55118	50.8 = 2.0	87.0 = 3.42519
15.0 = .59055	51.0 = 2.00787	88.0 = 3.46456
16.0 = .62992	52.0 = 2.04724	88.9 = 3.5
17.0 = .66929	53.0 = 2.08661	89.0 = 3.50393
18.0 = .70866	54.0 = 2.12598	90.0 = 3.54330
19.0 = .74803	55.0 = 2.16535	91.0 = 3.58267
20.0 = .78740	56.0 = 2.20472	92.0 = 3.62204
21.0 = .82677	57.0 = 2.24409	93.0 = 3.66141
22.0 = .86614	58.0 = 2.83460	94.0 = 3.70078
23.0 = .90551	59.0 = 2.32283	95.0 = 3.74015
24.0 = .94488	67.0 = 2.36220	96.0 = 3.77952
25.0 = .98425	61.0 = 2.40157	97.0 = 3.81889
25.4 = 1.0	62.0 = 2.44094	98.0 = 3.85826
26.0 = 1.02362	63.0 = 2.48031	99.0 = 3.89763
27.0 = 1.06299	63.5 = 2.5	100.0 = 3.93700
28.0 = 1.10236	64.0 = 2.51968	100.6 = 4.0

## Needle tubing equivalents

SIZE GUAGE NO.	APPROX. O.D.	
	MM	INCHES
26	.4	.018
24	.5	.022
22	.7	.028
20	.9	.035
18	1.3	.053
16	1.6	.065
14	2.1	.083
12	2.8	.109
10	3.4	.134
8	4.2	.165
6	5.1	.203

## Suction tubing equivalents

SIZE FRENCH GUAGE NO.	APPROX. O.D.	
	MM	INCHES
3	1.0	.039
4	1.3	.053
5	1.7	.066
6	2.0	.079
7	2.3	.092
8	2.7	.105
9	3.0	.118
10	3.3	.131
11	3.7	.144
12	4.0	.158
13	4.3	.170
14	4.7	.184
15	5.0	.197
16	5.3	.210

**Medtronic**

Engineering the extraordinary

ENT product catalog

# Office-based solutions



# Office-based solutions

## XPS Nexus™ ENT power console

- Connects to the StraightShot™ M4 microdebrider
- Handpiece recognition
- Portable
- Built-in irrigation pump
- Foot pedal with non-slip design (sold separately)
- IV pole (sold separately)



1894510

Product	Description	Qty
1894510	XPS Nexus console	1

## Integrated Power Console (IPC™) system

Our IPC™ system is a powered ENT surgery console with a range of application-specific products.



1898001



1898430



1898600

Product	Description	Qty
1898001	Integrated power console	1
1898430	Integrated power console multifunction foot pedal	1
1897510	Basket	1
1898600	IPC cart	1

## IPC™ system power cords

Product	Description	Qty
1895820	Power cord, standard, North America, 3 M	1
1897821	Power cord, standard, North America, 6 M	1

## StraightShot™ M4 microdebrider handpiece

Compatible with the IPC™ and the XPS Nexus™

- Rotatable blade options



1898200T

Product	Description	Qty
1898200T	StraightShot M4 high-speed microdebrider with SureTrack	1

## StraightShot™ M5 microdebrider

The StraightShot™ M5 works with:

- 30K high-speed burs
- Factory-calibrated EM blades for Fusion™ ENT navigation
- Quadcut™ blades
- Cross-compatible with M4 blades and burs



1899200

Product	Description	Qty
1899200	StraightShot M5 microdebrider	1

# Office-based solutions

## StealthStation FlexENT™ navigation system

### Cart configurations

Ordering code	FLEXCARTSIDE STAND	FLEXCARTSIDE CLAMP
Side emitter	✓	✓
Emitter stand	✓	
Bedrail clamp		✓

### Desktop configurations

Ordering code	FLEXDESKSIDE STAND	FLEXDESKSIDE CLAMP
Side emitter	✓	✓
Emitter stand	✓	
Bedrail clamp		✓

- 9736226 - StealthStation FlexENT™ software license
- 9736227 - Planning, annotations, and virtual endoscopy
- 9736155 - StealthMerge™ software
- 9735742 - Stealth™ 3D software
- 9733533XOM - Instrument tracker, ENT
- 9734887XOM - AxiEM™ non-invasive patient tracker



## NuVent™ EM sinus dilation system with integrated navigation

- For use with Medtronic ENT electromagnetic (EM) navigation
- Frontal, maxillary, and sphenoid designs
- 5 mm, 6 mm, and 7 mm balloon size options

Product	Description	Qty
<b>70 degree balloons</b>		
1830517FRT70	70 degree balloon 5.0 mm x 17.0 mm	1
1830617FRT70	70 degree balloon 6.0 mm x 17.0 mm	1
1830717FRT70	70 degree balloon 7.0 mm x 17.0 mm	1
<b>Frontal balloons</b>		
1830517FRT	Balloon seeker, EM frontal balloon 5.0 mm x 17.0 mm	1
1830617FRT	Balloon seeker, EM frontal balloon 6.0 mm x 17.0 mm	1
1830717FRT	Balloon seeker, EM frontal balloon 7.0 mm x 17.0 mm	1
<b>Maxillary balloons</b>		
1830507MAX	Balloon seeker, EM maxillary balloon 5.0 mm x 7.0 mm	1
1830607MAX	Balloon seeker, EM maxillary balloon 6.0 mm x 7.0 mm	1
1830707MAX	Balloon seeker, EM maxillary balloon 7.0 mm x 7.0 mm	1
<b>Sphenoid balloons</b>		
1830517SPH	Balloon seeker, EM sphenoid balloon 5.0 mm x 17.0 mm	1
1830617SPH	Balloon seeker, EM sphenoid balloon 6.0 mm x 17.0 mm	1
1830717SPH	Balloon seeker, EM sphenoid balloon 7.0 mm x 17.0 mm	1
<b>Inflator</b>		
18INFKIT	Kit, inflator	1



NuVent balloon package

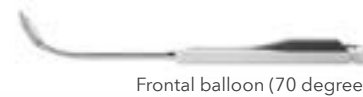

Frontal balloon (70 degree)



Frontal balloon (98 degree)



Maxillary balloon



Sphenoid balloon

## Office-based solutions

### NuVent™ Eustachian tube dilation balloon

1830616EST	Balloon Eustachian tube 6.0mm x 16.0 mm	1
------------	---	---

#### Inflator

18INFKIT	Kit, inflator	1
----------	---------------	---



NuVent™ Eustachian tube dilation balloon

### HydroCleanse™ sinus wash delivery system

- 360-degree rotating fan spray
- Sinus-specific suction catheter tips with three angles
- Adjustable spray pressure controlled by self-returning hand grip

Product	Description	Qty
1960100	HydroCleanse sinus wash delivery system	1



1960100

### Novapak™ nasal sinus packing and stent

- A single-use nasal packing and stent for use following sinus surgery
- Dimensions 8 cm x 1.8 cm x 1.3 cm

Product	Description	Qty
CS3600-2	Novapak™ nasal packing, 2PK STD	2
CS3900-2	Novapak nasal packing, 2PK FRM	2



### Localized drug delivery

#### PROPEL™ mometasone furoate family of sinus implants

Product	Description	Qty
70011	PROPEL mometasone furoate implant	1
700115	PROPEL mometasone furoate implant	5
60011	PROPEL Mini mometasone furoate implant	1
600115	PROPEL Mini mometasone furoate implant	5
50011-	PROPEL Contour mometasone furoate implant	1
50011-5	PROPEL Contour mometasone furoate implant	5
60044-	PROPEL Mini implant with straight delivery system (SDS)	1
60044-5	PROPEL Mini implant with straight delivery system (SDS)	5

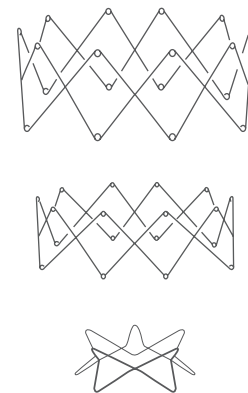

For more information refer to <https://propelopens.com/>

### SINUVA™ (mometasone furoate) sinus implant

NDC number	Description	Qty
10599000301	SINUVA™ (mometasone furoate) 1350 mcg	1



# Office-based solutions

## SINUVA™ (mometasone furoate) sinus implant

### Ordering

SINUVA implants can be obtained through two accessible avenues:

1. Specialty distributor: providers can purchase SINUVA implants directly from a distributor. Benefits verification and prior authorization from the payer is recommended prior to implanting a patient.
2. Specialty pharmacies: In some cases, SINUVA implants can be filled under the pharmacy benefit by a select specialty pharmacy and delivered directly to the provider. Verifying the patient's benefits will establish the path to fulfillment.

### SINUVA Indication & Important Safety Information

#### INDICATION

SINUVA Sinus Implant is a corticosteroid-eluting (mometasone furoate) implant indicated for the treatment of nasal polyps, in patients  $\geq 18$  years of age who have had ethmoid sinus surgery.

#### IMPORTANT SAFETY INFORMATION

##### CONTRAINDICATIONS

Patients with known hypersensitivity to mometasone furoate and any of the ingredients of the SINUVA should not use SINUVA.

##### WARNINGS AND PRECAUTIONS

**Local effects:** Monitor nasal mucosa adjacent to the SINUVA Sinus Implant for any signs of bleeding (epistaxis), irritation, infection, or perforation. Avoid use in patients with nasal ulcers or trauma.

**Ocular effects:** Monitor patients with a change in vision or with a history of increased intraocular pressure, glaucoma, and/or cataracts closely.

**Hypersensitivity reactions:** Hypersensitivity reactions, including rash, pruritus, and angioedema have been reported with the use of corticosteroids.

**Immunosuppression:** Persons who are using drugs that suppress the immune system are more susceptible to infections than healthy individuals. Corticosteroids should be used with caution, if at all, in patients with active or quiescent tuberculosis infection of the respiratory tract; untreated systemic fungal, bacterial, viral, or parasitic infections; or ocular herpes simplex.

**Hypercorticism and adrenal suppression:** If corticosteroid effects such as hypercorticism and adrenal suppression appear in patients, consider sinus implant removal.

##### ADVERSE REACTIONS

The most common adverse reactions observed ( $> 1\%$  of subjects and that occurred more frequently in the treatment group compared to control) in clinical studies were asthma, headache, epistaxis, presyncope, bronchitis, otitis media, and nasopharyngitis.

##### POSTMARKETING EXPERIENCE

The following adverse reactions have been identified during post-approval use of the SINUVA sinus implant. These events include implant migration, lack of efficacy, nasal pain, headache, epistaxis.

Rx only. Please see Full Prescribing Information for SINUVA at [www.SINUVA.com/PI](http://www.SINUVA.com/PI)

**Medtronic**

Engineering the extraordinary

ENT product catalog

# Powered surgical equipment

# Powered ENT system and components, IPC™

## Integrated Power Console (IPC™) system

Our IPC™ system is a powered ENT surgery console with a range of application-specific products.

Product	Description	Qty
1898001	Integrated power console	1
1898430	Integrated power console multifunction foot pedal	1
1897510	Basket	1
1898600	IPC cart	1



1898001

## IPC™ system power cords

Product	Description	Qty
1895820	Power cord, standard, North America, 3 M	1
1897821	Power cord, standard, North America, 6 M	1



1898430

## IPC™ system manuals

Product	Description	Qty
1898851	IPC manual (English only)	1
1898851A	IPC manual (EL, EN, ES, FR, PT)	1
1898851B	IPC manual (DE, EN, FR, IT, NL)	1
1898851C	IPC manual (DA, EN, FI, NO, SV)	1
1898851D	IPC manual (CS, EN, HU, PL, TR)	1
1898851E	IPC manual (EN, RU) – CD only	1

## IPC™ suction irrigation set with IntelliFlow™ remote control

System includes:  
 Coextruded suction-irrigation tubing set  
 Multi-size irrigation tip adapters (4) IntelliFlow™ remote control

Product	Description	Qty
3318604E	IPC suction-irrigation system	1



1898600



3318604E

# Powered ENT system and components, XPS Nexus™

## XPS Nexus™ ENT power console

- Connects to the StraightShot™ M4 microdebrider
- Handpiece recognition
- Portable
- Built-in irrigation pump
- Foot pedal with non-slip design (sold separately)
- IV pole (sold separately)



1894510

Product	Description	Qty
1894510	XPS Nexus console	1
1894520	XPS Nexus foot control	1
1894515	XPS Nexus IV pole	1
1897821	Power cord, 6 meter, IEC 320, 115V	1

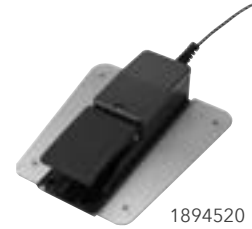

1894520



1894515

# Powered ENT system and components, microdebridors

## StraightShot™ M5 Microdebrider

The StraightShot™ M5 works with:

- 30K high-speed burs
- Factory-calibrated EM blades for ENT navigation
- Quadcut™ blades
- Cross-compatible with M4 blades and burs

Product	Description	Qty
1899200	StraightShot M5 microdebrider	1
1899076	StraightShot M5 instrument tray	1



## StraightShot™ M4 microdebrider handpiece

Compatible with the IPC™ and the XPS™ Nexus

- Rotating blade and handpiece

Product	Description	Qty
1898200T	StraightShot M4 high-speed microdebrider with SureTrack	1
1898075	StraightShot M4 instrument tray	1
1895522	StraightShot M4 tubing	5





# Powered ENT system and components, microdebriders

## Hydrodebrider™ system

### Power and access

- Powered irrigation system for the paranasal sinuses
- With a rotating spray, the flex-tip incorporates suction and 270° articulation

Product	Description	Qty
1913001	Hydrodebrider console	1
1914001	Hydrodebrider, standard handpiece	1
1921002	Hydrodebrider, frontal handpiece	1



1913001

## Hydrodebrider – powered ENT power cords

Product	Description	Qty
1895820	Power cord, standard, 3 M	1
1897821	Power cord, standard, 115V, 6 M	1



1914001



Standard handpiece tip close-up



1921002

Frontal handpiece tip close-up

# 30K burs for the StraightShot™ M5

## 30K burs

Product	Description	Length	Qty
1884015RTD	30K tapered diamond choanal atresia bur, 4.0 mm, 15°	13 cm	1
1883040BLD	30K bullet diamond bur, 3.0 mm, 40°	13 cm	1
1883040BLC	30K bullet cutting bur, 3.0 mm, 40°	13 cm	1
1884040RTC	30K reverse tapered cutting bur, 4.0 mm, 40°	13 cm	1
1883040BRC	30K frontal finesse barrel cutting bur, 3.0 mm, 40°	13 cm	1
1883655BRC	30K barrel cutting bur, 3.6 mm, 55°	13 cm	1
1884070RTD	30K reverse tapered diamond bur, 4.0 mm, 70°	13 cm	1
1884070RTC	30K reverse tapered cutting bur, 4.0 mm, 70°	13 cm	1
1883070BLD	30K bullet diamond bur, 3.0 mm, 70°	13 cm	1
1883070BLC	30K bullet cutting bur, 3.0 mm, 70°	13 cm	1

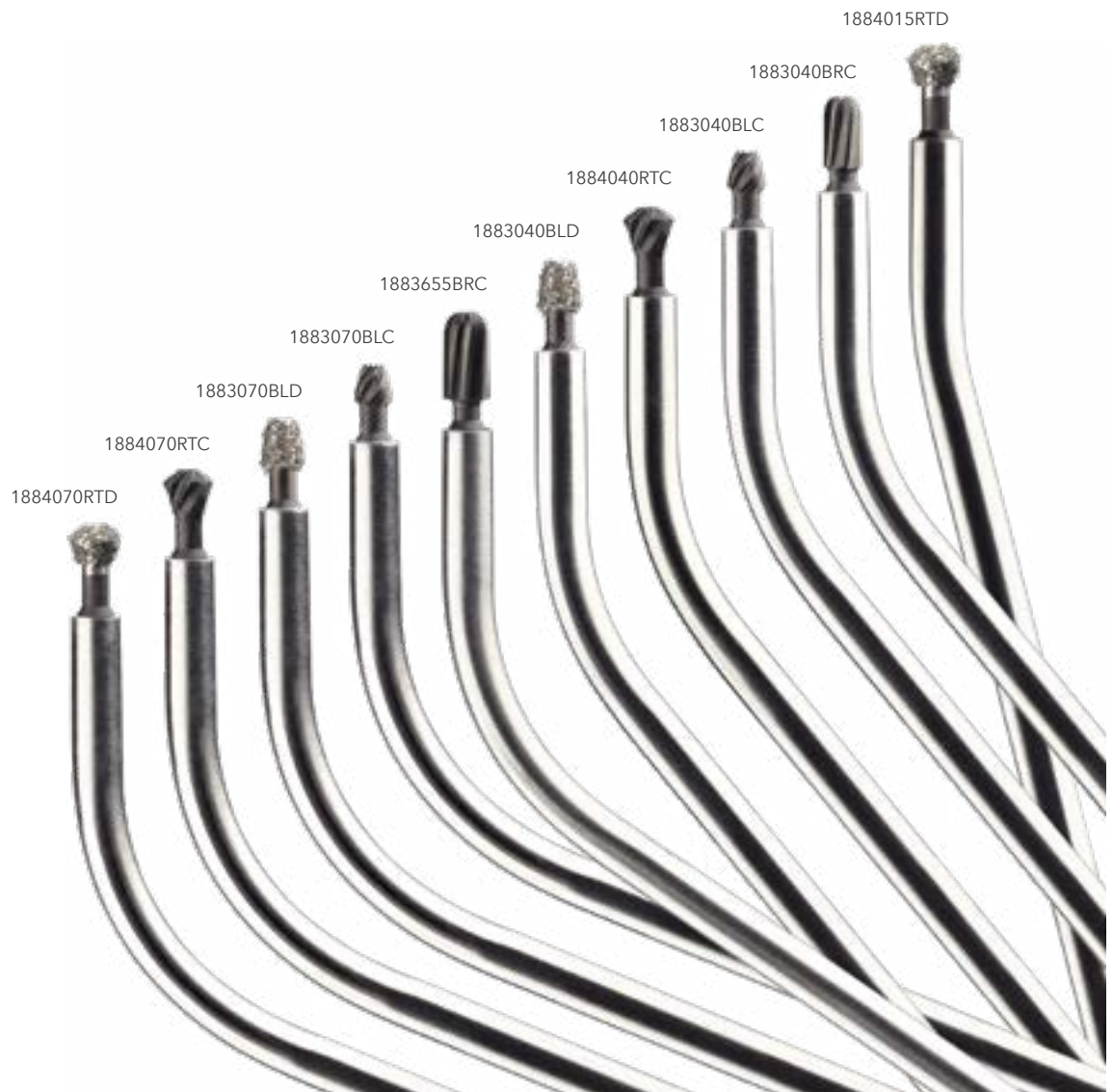

Maximum speed for 30K burs is 12,000 rpm when used with StraightShot™ M4 microdebrider handpiece

# Automated EM tracking blades for the StraightShot™ M4/M5 rotatable

## QUADCUT™ BLADES



### 4.3 mm Quadcut™ straight rotatable blade with automated EM tracking 1884380EM

- 13.0 cm long with straight shaft
- Rotates through 360°
- Operating speed: up to 7,500 rpm, oscillate
- 1 each with irrigation tubing



### 3.4 mm Quadcut™ straight rotatable blade with automated EM tracking 1883480EM

- 13.0 cm long with straight shaft
- Rotates through 360°
- Operating speed: up to 7,500 rpm, oscillate
- 1 each with irrigation tubing



### 3.0 mm Quadcut™ straight rotatable blade with automated EM tracking 1883080EM

- 13.0 cm long with straight shaft
- Rotates through 360°
- Operating speed: up to 7,500 rpm, oscillate
- 1 each with irrigation tubing

## TRICUT™ BLADE



### 4.0 mm Tricut™ straight rotatable blade with automated EM tracking 1884080EM

- 13.0 cm long with straight shaft
- StraightShot™ M4 rotates blade tip 360° without shaft rotation
- Operating speed: up to 7,500 rpm, oscillate
- 1 each with irrigation tubing

## RAD™ BLADES



### 4.0 mm RAD™ 12 curved rotatable blade with automated EM tracking 1884012EM

- 11.0 cm long with curved shaft
- StraightShot™ M4 rotates blade tip 360° without shaft rotation
- Operating speed: up to 7,500 rpm, oscillate
- 1 each with irrigation tubing

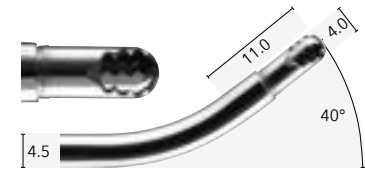

### 4.0 mm RAD™ 40 curved rotatable blade with automated EM tracking 1884006EM

- 11.0 cm long with curved shaft
- StraightShot™ M4 rotates blade tip 360° without shaft rotation
- Operating speed: up to 7,500 rpm, oscillate
- 1 each with irrigation tubing

## IRRIGATION TUBING

### Irrigation tubing for blades and burs 1895522

- For use with IPC™ blades and burs
- 5 each

Speeds are suggested rpm (revolutions per minute), operated in oscillation mode for blades and (forward) mode for burs.  
Measurements are listed in millimeters unless otherwise specified.

# Quadcut™ blades for the StraightShot™ M4 and M5

## QUADCUT™ BLADES

360°



### **4.3 mm Quadcut™ blade** **1884380HR**

- 13.0 cm long with straight shaft
- Rotates through 360°
- Operating speed: up to 7,500 rpm, oscillate
- 5 each with irrigation tubing

## QUADCUT™ BLADES

360°



### **3.4 mm Quadcut™ blade** **1883480HRE**

- 13.0 cm long with straight shaft
- Rotates through 360°
- Operating speed: up to 7,500 rpm, oscillate
- 1 each with irrigation tubing

## QUADCUT™ BLADES

360°



### **3.0 mm Quadcut™ blade** **1883080HRE**

- 13.0 cm long with straight shaft
- Rotates through 360°
- Operating speed: up to 7,500 rpm, oscillate
- 1 each with irrigation tubing

*Speeds are suggested rpm (revolutions per minute), operated in oscillation mode for blades and (forward) mode for burs.  
Measurements are listed in millimeters unless otherwise specified.*

# Straight sinus blades, M4 rotatable

## TRICUT™ BLADES



### **4.0 mm Tricut™ blade** **1884004HR**

- 11.0 cm long with straight shaft
- Rotates through 360°
- Operating speed: up to 7,500 rpm, oscillate
- 5 each with irrigation tubing

### **4.0 mm Tricut™ blade** **1884080HR**

- 13.0 cm long with straight shaft
- Rotates through 360°
- Operating speed: up to 7,500 rpm, oscillate
- 5 each with irrigation tubing

## TRICUT™ BLADES



### **3.5 mm Tricut™ blade** **1883504HR**

- 11.0 cm long with straight shaft
- Rotates through 360°
- Operating speed: up to 7,500 rpm, oscillate
- 5 each with irrigation tubing



### **2.9 mm Tricut™ blade** **1882904HRE**

- 11.0 cm long with straight shaft
- Rotates through 360°
- Operating speed: up to 7,500 rpm, oscillate
- 1 each with irrigation tubing

## SERRATED BLADES



### **4.0 mm Serrated blade** **1884002HRE**

- 11.0 cm with straight shaft
- Rotates through 360°
- Operating speed: up to 7,500 rpm, oscillate
- 1 each with irrigation tubing



### **3.5 mm serrated blade** **1883502HRE**

- 11.0 cm long with straight shaft
- Rotates through 360°
- Operating speed: up to 7,500 rpm, oscillate
- 1 each with irrigation tubing



### **2.9 mm serrated blade** **1882902HRE**

- 11.0 cm long with straight shaft
- Rotates through 360°
- Operating speed: up to 7,500 rpm, oscillate
- 1 each with irrigation tubing

# Straight sinus blades, M4 rotatable

## SILVER BULLET™



### **4.0 mm Silver Bullet™ blade** **1884005HRE**

- 11.0 cm long with straight shaft
- Rotates through 360°
- Operating speed: up to 7,500 rpm, oscillate
- 1 each with irrigation tubing
- Developed in conjunction with Rodney Lusk, MD



### **2.9 mm Silver Bullet™ blade** **1882905HRE**

- 11.0 cm long with straight shaft
- Rotates through 360°
- Operating speed: up to 7,500 rpm, oscillate
- 1 each with irrigation tubing
- Developed in conjunction with Rodney Lusk, MD

## TURBINATE



### **2.9 mm inferior turbinate blade** **1882940HR**

- 11.0 cm long
- Rotates through 360°
- Straight shaft with elevator
- Operating speed: up to 3,000 rpm, oscillate
- 5 each with irrigation tubing
- Developed in conjunction with Laurence O'Halloran, MD



### **2.0 mm inferior turbinate blade** **1882040HR**

- 11.0 cm long
- Rotates through 360°
- Straight shaft with elevator
- Operating speed: up to 3,000 rpm, oscillate
- 5 each with irrigation tubing
- Developed in conjunction with Laurence O'Halloran, MD

# Curved sinus blades, M4 rotatable

## RAD™ 12 BLADES

360°

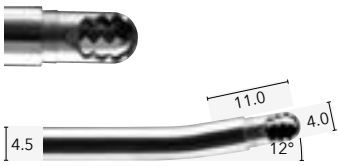

### 4 mm RAD™ 12 blade 1884012HR

- 11.0 cm long with curved shaft
- StraightShot™ M4 rotates blade tip 360° without shaft rotation
- Operating speed: up to 7,500 rpm, oscillate
- 5 each, irrigation tubing separate

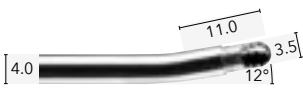

### 3.5 mm RAD™ 12 blade 1883512HRE

- 11.0 cm long with curved shaft
- StraightShot™ M4 rotates blade tip 360° without shaft rotation
- Operating speed: up to 7,500 rpm, oscillate
- 1 each, irrigation tubing separate

## IRRIGATION TUBING

### Irrigation tubing for blades and burs 1895522

- For use with XPS™ blades and burs
- 5 each

## RAD™ 40 BLADES

360°

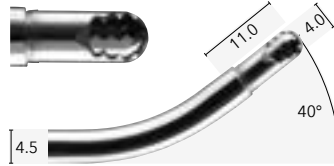

### 4 mm RAD™ 40 blade 1884006HR

- 11.0 cm long with curved shaft
- StraightShot™ M4 rotates blade tip 360° without shaft rotation
- Operating speed: up to 7,500 rpm, oscillate
- 5 each, irrigation tubing separate



### 3.5 mm RAD™ 40 blade 1883506HRE

- 11.0 cm long with curved shaft
- StraightShot™ M4 rotates blade tip 360° without shaft rotation
- Operating speed: up to 7,500 rpm, oscillate
- 1 each, irrigation tubing separate

## RAD™ 90 BLADE

360°

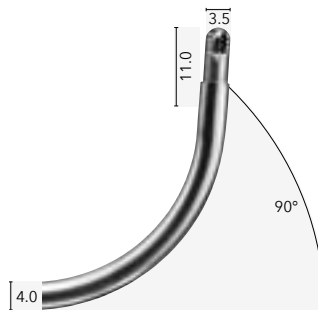

### 3.5 mm RAD™ 90 blade 1883519HR

- 11.0 cm long with curved shaft
- StraightShot™ M4 rotates blade tip 360° without shaft rotation
- Operating speed: up to 3,000 rpm, oscillate
- 3 each, irrigation tubing separate

## RAD™ 60 BLADES

360°

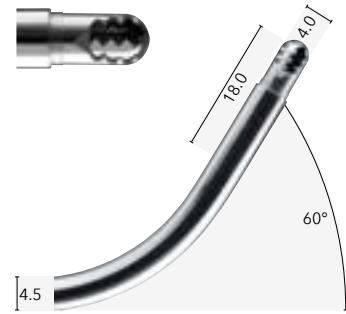

### 4 mm RAD™ 60 blade 1884016HR

- 11.0 cm long with curved shaft
- StraightShot™ M4 rotates blade tip 360° without shaft rotation
- Operating speed: up to 5,000 rpm, oscillate
- 5 each, irrigation tubing separate

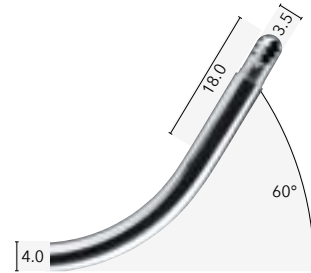

### 3.5 mm RAD™ 60 blade 1883516HRE

- 11.0 cm long with curved shaft
- StraightShot™ M4 rotates blade tip 360° without shaft rotation
- Operating speed: up to 5,000 rpm, oscillate
- 1 each, irrigation tubing separate

# Curved sinus blades, non-rotatable

## RAD™ 60 BLADE



### **2.9 mm RAD™ 60 blade** **1882916**

- 11.0 cm long with curved shaft
- Operating speed: up to 1,500 rpm, oscillate
- 3 each, irrigation tubing separate

## RAD™ 120 BLADE

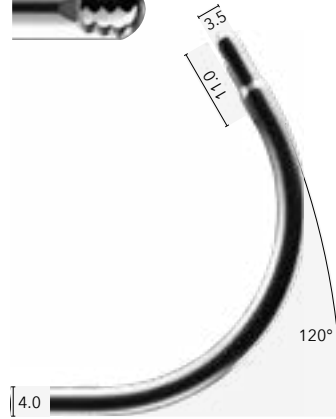

### **3.5 mm RAD™ 120 blade** **1883517**

- 11.0 cm long with curved shaft
- Operating speed: up to 7,500 rpm, oscillate
- 3 each, irrigation tubing separate



# Straight sinus burs

## OVAL BUR



### **3.2 mm oval bur, high-speed** **1883264HS**

- 12.5 cm long with straight shaft
- Operating speed: up to 12,000 rpm (forward)
- 3 each, irrigation tubing separate

## ROUND BURS



### **4.5 mm round bur, high-speed** **1884560HS**

- 12.5 cm long with straight shaft
- Operating speed: up to 12,000 rpm (forward)
- 3 each, irrigation tubing separate



### **3.2 mm round bur, high-speed** **1883262HS**

- 12.5 cm long with straight shaft
- Operating speed: up to 12,000 rpm (forward)
- 3 each, irrigation tubing separate



### **2.9 mm pediatric round bur** **1882960**

- 10.0 cm long with straight shaft
- Operating speed: up to 5,000 rpm (forward)
- 5 each, irrigation tubing separate

## ROUTER BUR



### **4.5 mm aggressive router bur, high-speed** **1884562HS**

- 12.5 cm long with straight shaft
- Operating speed: up to 12,000 rpm (forward)
- 3 each, irrigation tubing separate

# Straight sinus bur accessories

DRILL BIT



**Maxillary trephination**  
**5.0 mm drill bit**  
**1884501**

- Developed in conjunction with PJ Wormald, MD

# Curved sinus burs, anterior skull base

## ASB CUTTING BUR

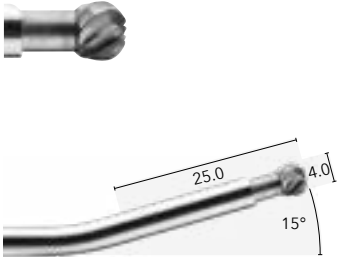

**4 mm anterior skull base cutting bur,\* 15°**  
**1884075HSE**

- 15.0 cm long
- Operating speed: up to 12,000 rpm (forward)
- 1 each, irrigation tubing separate
- Developed in conjunction with PJ Wormald, MD, and Aldo Stamm, MD

## ASB DIAMOND BURS

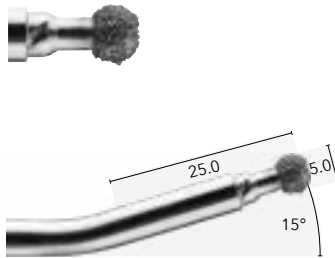

**5 mm anterior skull base diamond bur,\* 15°**  
**1885076HSE**

- 15.0 cm long
- Operating speed: up to 12,000 rpm (forward)
- 1 each, irrigation tubing separate
- Developed in conjunction with PJ Wormald, MD, and Aldo Stamm, MD

## ASB DIAMOND BURS

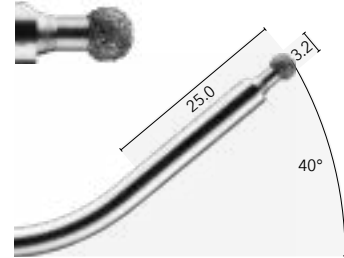

**3.2 mm anterior skull base diamond bur,\* 40°**  
**1883277HSE**

- 15.0 cm long
- Operating speed: up to 12,000 rpm (forward)
- 1 each, irrigation tubing separate
- Developed in conjunction with PJ Wormald, MD, and Aldo Stamm, MD

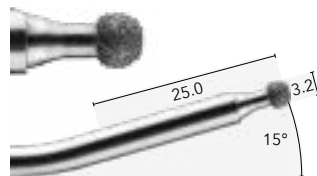

**3.2 mm anterior skull base diamond bur,\* 15°**  
**1883274HSE**

- 15.0 cm long
- Operating speed: up to 12,000 rpm (forward)
- 1 each, irrigation tubing separate
- Developed in conjunction with PJ Wormald, MD, and Aldo Stamm, MD

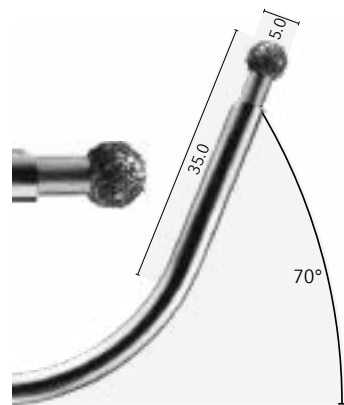

**5 mm anterior skull base diamond bur,\* 70°**  
**1885078HSE**

- 13.0 cm long
- Operating speed: up to 12,000 rpm (forward)
- 1 each, irrigation tubing separate
- Developed in conjunction with PJ Wormald, MD, and Aldo Stamm, MD

# Curved sinus burs

## ROUND DIAMOND BUR

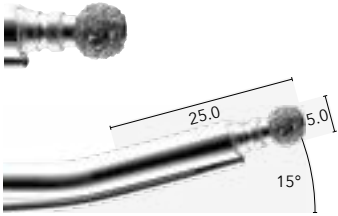

### 5 mm curved round diamond bur, high-speed 1885061HS

- 12.5 cm long with curved shaft
- Operating speed: up to 12,000 rpm (forward)
- 3 each, irrigation tubing separate
- Developed in conjunction with David Kennedy, MD

## DCR BURS

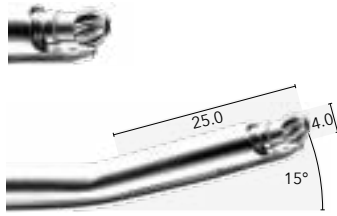

### 4 mm curved DCR bur, high-speed 1884068HS

- 11.0 cm long with curved shaft
- Operating speed: up to 12,000 rpm (forward)
- 3 each, irrigation tubing separate
- Developed in conjunction with Michael Mercandetti, MD

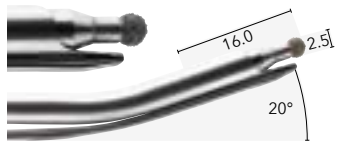

### 2.5 mm curved diamond DCR bur, high-speed 1882569HS

- 11.0 cm long with curved shaft
- Operating speed: up to 12,000 rpm (forward)
- 3 each, irrigation tubing separate
- Developed in conjunction with PJ Wormald, MD

## SEPTOPLASTY BUR

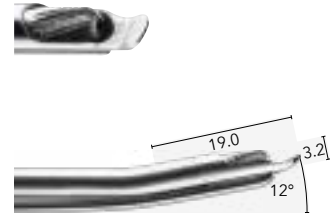

### 3.2 mm septoplasty bur, high-speed 1883212HS

- 11.0 cm long with curved shaft
- Operating speed: up to 12,000 rpm (forward)
- 3 each, irrigation tubing separate
- Developed in conjunction with Donald Leopold, MD, and Eileen Raynor, MD

# Tonsillectomy and adenoidectomy blades

## RADENOID™ BLADES

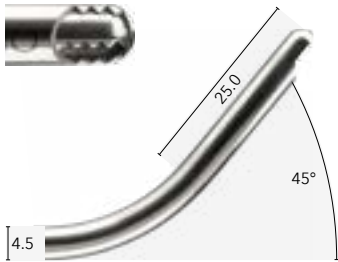

### 4.5 mm RADenoid™ adult blade 1884507

- 13.0 cm long with curved 45° blade
- Operating speed: 1,500 rpm
- 5 each, irrigation tubing separate
- Designed in conjunction with Max April, MD, and J. Lindhe Guarisco, MD



### 4 mm RADenoid™ blade 1884008

- 11.0 cm long with curved 40° blade
- Operating speed: 1,500 rpm
- 5 each, irrigation tubing separate
- Designed in conjunction with Max April, MD, and J. Lindhe Guarisco, MD

## TONSILLECTOMY BLADE



### 4 mm tonsillectomy blade 1884013

- 11.0 cm
- 12° blade
- Operating speed: 1,500 rpm
- 5 each, irrigation tubing separate

## T&A BLADE SET



### Powered T&A blade set 1884008TA

- 13.0 cm
- Removable inner cutting tube
- Operating speed: 1,500 rpm
- 5 each, irrigation tubing separate
- Developed in conjunction with Peter J. Koltai, MD

# Airway blades, M4 rotatable

## SKIMMER™ BLADES



### 2.9 mm Skimmer™ angle-tip blade 1882979HRE

- 13.0 cm long double-curved blade
- Operating speed: 60-500 rpm
- 15°
- 1 each with irrigation tubing

### 2.9 mm Skimmer™ angle-tip blade 1882925HRE

- 18.0 cm long double-curved blade
- Operating speed: 60-500 rpm
- 15°
- 1 each with irrigation tubing

## SKIMMER™ BLADES



### 2.9 mm Skimmer™ angle-tip blade 1882923HRE

- 22.0 cm long double-curved blade
- Operating speed: 60-500 rpm
- 15°
- 1 each with irrigation tubing

### 2.9 mm Skimmer™ angle-tip blade 1882924HRE

- 27.0 cm long double-curved blade
- Operating speed: 60-500 rpm
- 15°
- 1 each with irrigation tubing

## TRICUT™ BLADES



### 4 mm Tricut™ angle-tip laryngeal blade 1884030HRE

- 22.0 cm long double-curved blade
- Operating speed: 500-1,200 rpm
- 1 each with irrigation tubing
- Developed in conjunction with William Lunn, MD, and Armin Ernst, MD

Speeds are suggested rpm (revolutions per minute), operated in oscillation mode for blades and (forward) mode for burs.  
Measurements are listed in millimeters unless otherwise specified.

# Airway blades, rotatable

## TRICUT™ BLADES



### **4 mm Tricut™ angle-tip subglottic blade** **1884031HRE**

- 27.0 cm long double-curved blade
- Operating speed: 500-1,200 rpm
- 1 each with irrigation tubing
- Developed in conjunction with William Lunn, MD, and Armin Ernst, MD

## TRICUT™ BLADES



### **4 mm Tricut™ angle-tip tracheal blade** **1884033HRE**

- 37.0 cm long double-curved blade
- Operating speed: 500-1,200 rpm
- 1 each with irrigation tubing
- Developed in conjunction with William Lunn, MD, and Armin Ernst, MD

## TRICUT™ BLADES



### **4 mm Tricut™ angle-tip bronchial blade** **1884035HRE**

- 45.0 cm long double-curved blade
- Operating speed: 500-1,200 rpm
- 1 each with irrigation tubing
- Developed in conjunction with William Lunn, MD, and Armin Ernst, MD

# Airway blades, non-rotatable

## SKIMMER™ BLADES



### **2.9 mm Skimmer™ angle-tip blade** **1882925**

- 18.0 cm long double-curved blade
- Operating speed: 60-500 rpm
- 3 each with irrigation tubing
- Developed in conjunction with Craig Derkay, MD, and David Darrow, MD

### **2.9 mm Skimmer™ angle-tip blade** **1882923**

- 22.5 cm long double-curved blade
- Operating speed: 60-500 rpm
- 3 each with irrigation tubing
- Developed in conjunction with Craig Derkay, MD, and David Darrow, MD

## SKIMMER™ BLADES



### **3.5 mm Skimmer™ angle-tip subglottic blade** **1883524**

- 27.5 cm long double-curved blade
- Operating speed: 60-500 rpm
- 3 each with irrigation tubing
- Developed in conjunction with Charles Myer, III, MD; Paul Wilging, MD; Brian Wiatrak, MD; Paul Flint, MD; David Parsons, MD; and John Little, MD

## SKIMMER™ BLADES



### **4 mm Skimmer™ angle-tip laryngeal blade** **1884023**

- 22.5 cm long double-curved blade
- Operating speed: 60-500 rpm
- 3 each with irrigation tubing
- Developed in conjunction with Charles Myer, III, MD; Paul Wilging, MD; Brian Wiatrak, MD; Paul Flint, MD; David Parsons, MD; and John Little, MD

### **4 mm Skimmer™ angle-tip subglottic blade** **1884024**

- 27.5 cm long double-curved blade
- Operating speed: 60-500 rpm
- 3 each with irrigation tubing
- Developed in conjunction with Charles Myer, III, MD; Paul Wilging, MD; Brian Wiatrak, MD; Paul Flint, MD; David Parsons, MD; and John Little, MD



# Airway blades, non-rotatable

## TRICUT™ BLADES



### 4 mm Tricut™ angle-tip laryngeal blade 1884030

- 22.5 cm long double-curved blade
- Operating speed: 1,500 rpm
- 3 each with irrigation tubing
- Developed in conjunction with Paul Flint, MD, and John Little, MD

### 4 mm Tricut™ angle-tip subglottic blade 1884031

- 27.5 cm long double-curved blade
- Operating speed: 1,500 rpm
- 3 each with irrigation tubing



### 4 mm Tricut™ straight-tip laryngeal blade 1884020

- 22.5 cm long
- Operating speed: 1,200 rpm
- 3 each with irrigation tubing
- Developed in conjunction with Paul Flint, MD, and John Little, MD

## SERRATED BLADES



### 4 mm serrated angle-tip tracheal blade 1884033

- 37.0 cm long
- Operating speed: 1,200 rpm
- 1 each with irrigation tubing
- Developed in conjunction with Paul Flint, MD



### 2.9 mm serrated angle-tip blade 1882936E

- 18.0 cm long double-curved blade
- Operating speed: 500-1,500 rpm
- 1 each with irrigation tubing

### 2.9 mm serrated angle-tip blade 1882937E

- 22.0 cm long double-curved blade
- Operating speed: 500-1,500 rpm
- 1 each with irrigation tubing

## TRACHEAL BLADE



### 4 mm straight tracheal blade 1884032

- 37.0 cm long
- Operating speed: 1,200 rpm
- 1 each with irrigation tubing
- Developed in conjunction with Paul Flint, MD, and John Little, MD

**Medtronic**

Engineering the extraordinary

ENT product catalog

# Endoscopy products

# ENT Slide-On™ EndoSheath™ system

## ENT Slide-On™ EndoSheath™ system

The EndoSheath System provides a sterile, disposable microbial barrier for use with flexible ENT scopes. It is indicated for endoscopic exams performed with a manufacturer-specific flexible nasopharyngoscope.

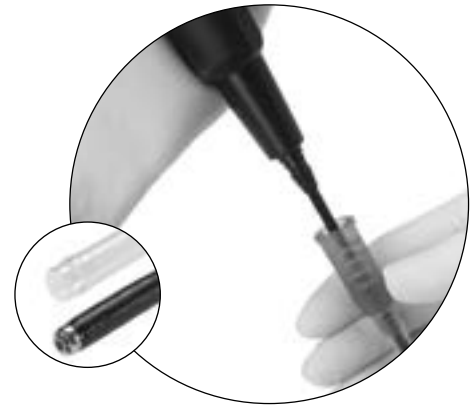

## ENT Slide-On™ EndoSheath™ system with working channel

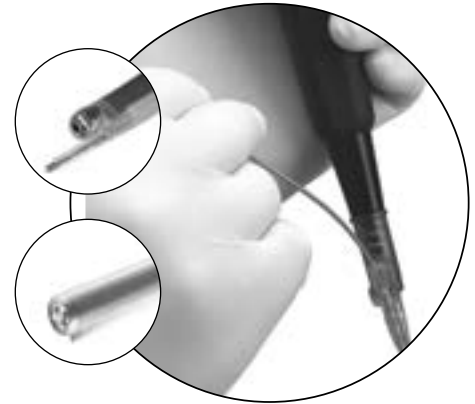

## Slide-On™ sensory sheath for flexible ENT scopes



# ENT Slide-On™ EndoSheath™ system

## Slide-On™ EndoSheath™ system selection guide

Make	Model	ENT sheath	ENT channel	ENT sensory	TNE
Olympus™	ENF-P2	224301	334301		
Olympus	ENF-P3	224301	334301		
Olympus	ENF-XP	224101			
Olympus	ENF-V	224501			
Olympus	ENF-V2	226401			
Olympus	ENF-VQ	225501			
Pentax™	FNL-10S	225401	335401	445401	
Pentax	FNL-10BS	225401	335401	445401	
Pentax	FNL-7RP3	224101			
Pentax	FNL-10RP2			335401	
Pentax	FNL-10RP3	225401	335401	445401	
Pentax	VNL-1130	225501			
Pentax	VNL-1190STK	225501			
Pentax	VNL-1170K	225501			
Pentax	VNL-1070STK	226401	336401		
Pentax	FNL-10RBS	225401	335401	445401	
Machida™	ENT-3L	225301			
Machida	ENT-4L	222401	332401		
Machida	ENT-2L	222101			
Machida	ENT-30PIII	225301			
Medtronic	1880500	225401	335401	445401	
Optim™	ENTity	224401		444401	
Optim	ENTity SD	225101			
Optim	ENTity XL	224401		444401	
Optim	ENTity SDXL	225101			
Optim	ENT 3.6F	224401			
Karl Storz™	11101RP	226301			
Karl Storz	11101RP-1	226401	336401	445401	
Karl Storz	11101RP2	226401	336401		
Karl Storz	11101SK1	226101			
Welch Allyn™	RL-150	225401	335401	445401	
Gyrus ACMI™	Duraview OL-1	225301			
Gyrus ACMI	800-600	225401		445401	
Vision Sciences™	ENT-4500	225101			
Vision Sciences	ENT-4000	225601	335601	445601	
Vision Sciences	ENT-3000	225401	335401	445401	
Vision Sciences	ENT-2000	225401	335401	445401	
Vision Sciences	ENT-1000	225101			
Vision Sciences	E-F100*	225301			
Xion™	EV-N	225501			
Xion	EF-NS	226401	336401		
Xion	EV-NE	222401	332401		
Xion	EV-NC			444401	
Richard Wolf	7224.001		335401	445401	
Richard Wolf	7224.001 S02		335401	445401	

\* Requires use of catalog number 021106, E-F100 Slide-On™ Endosheath™ adapter

# Endoscopes

## Medtronic sinuscopes

- Built-in wide-angle field of view of 0°, 30°, 45°, and 70° endoscopes
- Flash autoclaving produces a sterile scope and provides an alternative to soak solutions
- Color-coded for identification
- HD-compatible

Product	Diameter	Length	DOV	FOV	Color	Qty
31.0810a	2.7 mm	187.5 mm	0°	97°	Green	1
31.0811a	2.7 mm	187.5 mm	30°	87°	Red	1
31.0801a	4 mm	175 mm	0°	102°	Green	1
31.0802a	4 mm	175 mm	30°	100°	Red	1
31.0803a	4 mm	175 mm	70°	102°	Yellow	1
31.0809a	4 mm	175 mm	45°	95°	Black	1

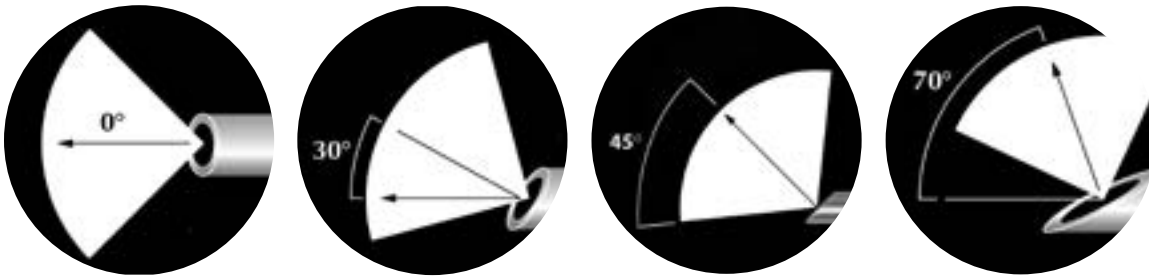

# Endo-Scrub™ 2 lens cleaning system

## Endo-Scrub™ 2 lens cleaning system accessories

Product	Description	Qty
1852000	Endo-Scrub 2 foot switch	1
1991015	Endo-Scrub finger switch	1
1912030	Endo-Scrub 2 tubing	5

## Endo-Scrub™ 2 sheaths

Item no.	Size	Angle	Compatible scopes	Qty
1912023	2.7 mm	0°	Karl Storz™, 27018A	5
1912002	4 mm	0°	Karl Storz, 7200A	5
1912000	4 mm	0°	Karl Storz, 7230AA	5
1912012	4 mm	30°	Karl Storz, 7200B	5
197230BVA	4 mm	30°	Karl Storz, 7230BVA	5
1912010	4 mm	30°	Karl Storz, 7230BA	5
1912013	4 mm	45°	Karl Storz, 7210FA	5
197230FLA	4 mm	45°	Karl Storz, 7230FLA	5
1912013	4 mm	45°	Karl Storz, 7230FA	5
197230CRA	4 mm	70°	Karl Storz, 7230CRA	5
197230CVA	4 mm	70°	Karl Storz, 7230CVA	5
1912020	4 mm	70°	Karl Storz, 7230CA	5
1912050	4 mm	0°	Linvatec™, HD4000R	5
1912051	4 mm	30°	Linvatec, HD4300R	5
1912051	4 mm	30°	Linvatec, QL4300R	5
1912023	2.7 mm	0°	Medtronic, 1880160	5
1912027	2.7 mm	30°	Medtronic, 1880161	5
1912000	4 mm	0°	Medtronic, 1880152	5
1912010	4 mm	30°	Medtronic, 1880153	5
1912015	4 mm	45°	Medtronic, 1880155	5
1912020	4 mm	70°	Medtronic, 1880154	5
1912032	4 mm	0°	Olympus™, A7594A	5
1912033	4 mm	0°	Olympus, A70940A	5
1912038	4 mm	0°	Olympus, WA96200A	5
1912031	4 mm	30°	Olympus, A7595A	5
1912034	4 mm	30°	Olympus, A70941A	5
1912039	4 mm	30°	Olympus, WA96201A	5
1912036	4 mm	45°	Olympus, WA96203A	5
1912035	4 mm	70°	Olympus, A70942A	5
1912037	4 mm	70°	Olympus, WA96205A	5
1912008	4 mm	0°	Richard Wolf, 888.0431	5
1912008	4 mm	0°	Richard Wolf, 585412	5
1912018	4 mm	25°	Richard Wolf, 8475.42	5
1912019	4 mm	25°	Richard Wolf, 8885.433	5
1912019	4 mm	25°	Richard Wolf, 8880.433	5
1912024	2.7 mm	0°	Smith & Nephew™, 23-0853	5
1912028	2.7 mm	30°	Smith & Nephew, 23-0854	5
1912004	4 mm	0°	Smith & Nephew, 23-0850	5
1912004	4 mm	0°	Smith & Nephew, 70230910	5
1912014	4 mm	30°	Smith & Nephew, 23-0851	5
1912040	4 mm	0°	Stryker™, 502-477-011	5
1912041	4 mm	30°	Stryker, 502-477-031	5
1912042	4 mm	45°	Stryker, 502-477-045	5
1912043	4 mm	70°	Stryker, 502-477-071	5



Note: All 0° sheaths are packaged with tubing. Tubing may be purchased separately if a 0° sheath is not being used.

**Medtronic**

Engineering the extraordinary

ENT product catalog

# Navigation solutions

# ENT navigation solutions

## StealthStation™ ENT navigation system

Product	Description	Qty
9735669KIT	StealthStation™ ENT navigation system with power pack	1

## StealthStation FlexENT™ navigation system

### Cart configurations

Ordering code	FLEXCARTFLAT	FLEXCARTSIDESTAND	FLEXCARTSIDECLAMP
Flat emitter	✓		
Side emitter		✓	✓
Emitter stand		✓	
Bedrail clamp			✓

### Desktop configurations

Ordering code	FLEXDESKFLAT	FLEXDESKSIDESTAND	FLEXDESKSIDECLAMP
Flat emitter	✓		
Side emitter		✓	✓
Emitter stand		✓	
Bedrail clamp			✓

9736226 - StealthStation FlexENT™ software license

9736227 - Planning, annotations and virtual endoscopy

9736155 - StealthMerge™ software

9735742 - Stealth™ 3D software

\*Product codes may vary if ordered standalone or in a kit. Please confirm the correct product code for your site with your Medtronic representative.



## Reusable standard instrument set

Product	Description	Qty
9733452XOM	Reusable standard instrument set	1

Set Includes:

9733445	Head frame kit	1
9733446	Registration probe	1
9733447	Straight probe	1
9733449	Straight suction	1
9733450	Curved suction, 70°	1
9733451	Curved suction, 90°	1
9733448	Ostium seeker	1
9733455	Instrument tray	1
960363	Strap, ENT FESS	3
9732500XOM	Adhesive pad	25
9732501XOM	Silicone pad	3
9732379	Imaging protocol	1
9730713	Sterilization reference sheet	1

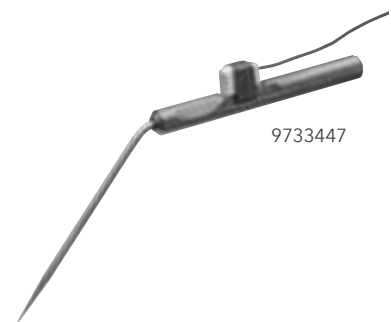
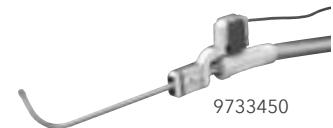

\*The Medtronic family of navigation systems (StealthStation™ ENT, Fusion™, and FUSION™ Compact) will work with the instrument sets, balloons, suctions, and blades listed on these pages.



# ENT navigation solutions

## Supplemental instrument set

Product	Description	Qty
9734378XOM	Supplemental instrument set	1

Set includes:

9734306	Frontal suction, 45°	1
9734307	Frontal suction, 90°	1
9734308	Small straight suction	1
9734311	Elevator	1
9733446	Registration probe	1
9733445	Head frame kit	1
9734320	Instrument tray	1
960363	Strap, ENT FESS	3
9732500XOM	Adhesive pad	25
9732501XOM	Silicone pad	3
9732379	Imaging protocol	1

## Optional accessories

Product	Description	Qty
9735960	Side emitter	1
9734691XOM	Surgeon mouse kit	1
9733533XOM	Instrument tracker, ENT	1
9733534XOM	Patient tracker, ENT	1
9734887XOM	Axiem™ non-invasive patient tracker	1
9732315	Wireless mouse cover, sterile	15
9731831XOM	Emitter cover, sterile	1
9731132	Dynamic reference (DRF) (EM, bone fixation)	5
9732500XOM	Adhesive pads	25
9734320XOM	Supplemental instrument tray	1



9734887XOM

## IGS software

Product	Description	Qty
9735736	StealthStation™ ENT software	1
9735920	StealthStation™ planning station ENT software	1
9736155	StealthMerge™ software	1
9735742	Stealth™ 3D software	1

## IGS software support program

Product	Description	Qty
SRVC2-9732560XOM2	StealthStation™ ENT service and support agreement	1
SERVICEH5-ENTMCT	StealthStation™ ENT service agreement	1
SSH5-SRVCFLEXENT	StealthStation FlexENT™ navigation system service and support agreement	1
SSH5-SRVCAFLEXENT	StealthStation FlexENT™ navigation system service and support advanced agreement	1

\*The Medtronic family of navigation systems (StealthStation™ ENT, Fusion™, and FUSION™ Compact) will work with the instrument sets, balloons, suctions, and blades listed on these pages.

# ENT navigation solutions

## Planning station

Product	Description	Qty
9735894KIT	StealthStation™ ENT planning station kit	1

Set includes:

9735894	Stealth S8 planning station	1
9736009	Power pack PS Stealth S8 English only	1

## NuVent™ EM sinus dilation system balloon dilation with integrated navigation

- For use with Medtronic ENT electromagnetic (EM) navigation
- Frontal, maxillary, and sphenoid designs
- 5 mm, 6 mm, and 7 mm balloon size options

Product	Description	Qty
---------	-------------	-----

### 70 degree balloons

1830517FRT70	70 degree balloon 5.0 mm x 17.0 mm	1
1830617FRT70	70 degree balloon 6.0 mm x 17.0 mm	1
1830717FRT70	70 degree balloon 7.0 mm x 17.0 mm	1

### Frontal balloons

1830517FRT	Balloon seeker, EM frontal balloon 5.0 mm x 17.0 mm	1
1830617FRT	Balloon seeker, EM frontal balloon 6.0 mm x 17.0 mm	1
1830717FRT	Balloon seeker, EM frontal balloon 7.0 mm x 17.0 mm	1

### Maxillary balloons

1830507MAX	Balloon seeker, EM maxillary balloon 5.0 mm x 7.0 mm	1
1830607MAX	Balloon seeker, EM maxillary balloon 6.0 mm x 7.0 mm	1
1830707MAX	Balloon seeker, EM maxillary balloon 7.0 mm x 7.0 mm	1

### Sphenoid balloons

1830517SPH	Balloon seeker, EM sphenoid balloon 5.0 mm x 17.0 mm	1
1830617SPH	Balloon seeker, EM sphenoid balloon 6.0 mm x 17.0 mm	1
1830717SPH	Balloon seeker, EM sphenoid balloon 7.0 mm x 17.0 mm	1

### Inflator

18INFKIT	Kit, inflator	1
----------	---------------	---



NuVent balloon package



70 degree balloon



Frontal balloon



Maxillary balloon



Sphenoid balloon

\*The Medtronic family of Navigation systems (StealthStation ENT, Fusion, and Fusion Compact) will work with the instrument sets, balloons, suction, and blades listed on these pages.

# ENT navigation solutions

## Malleable suction instruments

- Plug-and-play with Medtronic ENT electromagnetic (EM) navigation
- Multiple lengths, diameters, and tips
- Standard suction design with built-in EM tracker

Product	Description	Qty
9735015	Small standard tip, 14.5 cm	1
9735016	Medium standard tip, 16.5 cm	1
9735017	Medium angle tip, 16.5 cm	1
9735018	Medium ball tip, 16.5 cm	1
9735019	Large standard tip 20 cm	1



## StraightShot™ automated EM tracking blades

Product	Description	Qty
1884012EM	RAD™ 12 curved rotatable blade with automated EM tracking, 4 mm	1
1884006EM	RAD 40 curved rotatable blade with automated EM tracking, 4 mm	1
1884080EM	Tricut™ 13 cm straight rotatable blade with automated EM tracking, 4 mm	1
1895522	Irrigation tubing	5
1883080EM	Quadcut™ straight rotatable blade with automated EM tracking, 3.0 mm	1
1883480EM	Quadcut straight rotatable blade with automated EM tracking, 3.4 mm	1
1884380EM	Quadcut straight rotatable blade with automated EM tracking, 4.3 mm	1



## IGS instructional literature

Product	Description	Qty
9732379	Imaging protocol sheet	1

**Medtronic**

Engineering the extraordinary

ENT product catalog

# Nerve monitoring equipment

# NIM Vital™ nerve monitoring system

## NIM Vital™ nerve monitoring system

### System requirements

Product	Description	Qty
NIM4CM01	NIM Vital console	1
1897821	Console power cord North America, 6 meters	1
NIM4CPB1	NIM Vital patient interface 4 channel	1
NIM4CPB2	NIM Vital patient interface cable	1

### Accessories

Product	Description	Qty
NIM4CAM1	NIM Vital mute probe adaptor	1
NIMCAD400	NIM incrementing probe adaptor	1
NIM4CC01	NIM Vital cart	1
NIM4CC02	NIM Vital printer power isolator 100-120V power isolator for printer	1
NIM4CB01	NIM Vital console battery	1
NIM4CFU1	NIM Vital console fuse kit	1
8253075	NIM 3.0 INTFC 32MA fuse kit	1
8220325	NIM muting probe	1
8253600	Patient simulator, universal	1

### *NIM Vital™ nerve monitoring system compatible printers*

- Samsung Xpress m2020w wireless black-and-white laser printer
- HP OfficeJet 200 mobile printer wireless color inkjet printer
- Samsung Xpress C430W



# NIM-Neuro™ 3.0

## NIM-Neuro™ 3.0 nerve monitoring system accessories

Product	Description	Qty
8253401	Mainframe, NIM-Neuro™ 3.0	1
8253410	Patient interface box, 8-channel	1
8253600	Patient simulator, universal	1
8220325	NIM™ muting detector probe	1
8253050A	User guide, EN, SP, FR, PO, GR	1
8253062	Service manual	1



8253401



8253410

# EMG endotracheal tubes

## NIM TriVantage™ EMG endotracheal tube

- Recording electrode leads are twisted pair
- Packaged sterile with one green and one white subdermal needle
- Single use

Product	ID	OD	Qty
8229705	5.0 mm	6.5 mm	1
8229706	6.0 mm	8.2 mm	1
8229707	7.0 mm	9.5 mm	1
8229708	8.0 mm	10.7 mm	1
8229709	9.0 mm	12.0 mm	1
8229735	5.0 mm	6.5 mm	3
8229736	6.0 mm	8.2 mm	3
8229737	7.0 mm	9.5 mm	3
8229738	8.0 mm	10.7 mm	3
8229739	9.0 mm	12.0 mm	3



## NIM Contact™ EMG reinforced endotracheal tube

- Recording electrode leads are twisted pair
- Packaged sterile with one green and one white subdermal needle
- Single use

Product	ID	OD	Qty
8229506	6.0 mm	9.0 mm	1
8229507	7.0 mm	10.5 mm	1
8229508	8.0 mm	11.5 mm	1



## NIM™ EMG reinforced endotracheal tube

- Recording electrode leads are twisted pair
- Packaged sterile with one green and one white subdermal needle
- Single use

Product	ID	OD	Qty
8229306	6.0 mm	8.8 mm	1
8229307	7.0 mm	10.2 mm	1
8229308	8.0 mm	11.3 mm	1



All measurements in millimeters.  
ID = Inner Diameter, OD = Outer Diameter

# Probes: monopolar stimulating

## Incrementing probe\*

- Individual sterile packages
- Single use

Product	Description	Qty
8225825	Prass standard tip	3
8225490	Ball tip, 1 mm	3



## Standard prass flush-tip monopolar stimulator probe

- Individual sterile packages
- Single use

Product	Description	Qty
8225101	Probes (Tips and handles)	5
8225110	Tips only	10



## Yingling flex tip monopolar stimulator probe

- Packaged sterile with one green subdermal electrode
- Single use

Product	Description	Qty
8225251	Tips and handles	5



## Ball-tip monopolar stimulator probe

- Sterile, single use

Product	Description	Qty
8225275	Tip and handle, 1.0 mm	1
8225277	Tips only, 1.0 mm	10
8225276	Tip and handle, 2.3 mm	1
8225278	Tips only, 2.3 mm	10



## Monopolar probe handles

- Individual sterile packages
- Single use

Product	Description	Qty
8225051	Handles	10



\* For use with NIM-Response™ and NIM-Neuro™ models 2.0 or later.



# Probes: bipolar stimulating

## Prass bipolar stimulator probe

- Sterile, single use

Product	Description	Qty
8225451	Probes	5



## Concentric bipolar stimulating probe

- Sterile, single use

Product	Description	Qty
8225351	Probes	5



## Side-by-side bipolar stimulating probe

- Sterile, single use

Product	Description	Qty
8225401	Probes	5



## Other disposables

### APS™ (Automatic Periodic Stimulation) electrode\*

- Sterile, single use

Product	Description	Qty
8228052	2 mm, size range 2 mm to 3 mm	1
8228053	3 mm, Size range 3 mm to 4 mm	1



### Stim bur guard\*\*

- Sterile, single use

Product	Description	Qty
3318601	With irrigation	1 each
3318602	Without irrigation	1 each



\*For use with NIM Vital, NIM-Response™ 3.0 and NIM-Neuro™ 3.0 models only.

\*\*For use with NIM™ models 2.0 and later, the Visao™ high-speed otologic drill and Integrated Power Console (IPC™) system.

# Electrodes: recording

## EMG hookwire electrodes

- Sterile, single use

Product	Description	Qty
8226626	Single electrodes, 25 mm	6
8226326	Paired electrodes, 25 mm	1 set

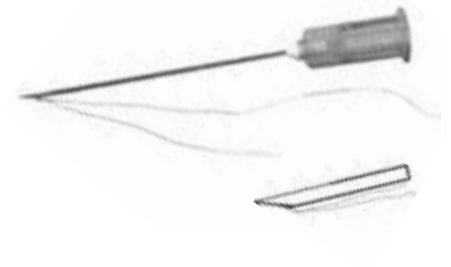

## Subdermal needle electrodes

- Packaged with one green and one white subdermal electrode
- Sterile, single use

Product	Description	Qty
8227103	2-channel, 12 mm	6



## Bulk-packed subdermal electrodes

- Packaged in 25 of one color or a mix of colors
- Sterile, lancet-tip needle electrodes
- Available in 10 different colors
- 12.0 mm needle electrodes with 5 ft. wire

Product	Description	Qty
8227131	Needle electrodes, yellow	25
8227133	Needle electrodes, violet	25
8227134	Needle electrodes, green	25
8227135	Needle electrodes, black	25
8227137	Needle electrodes, white	25
8227139	Needle electrodes, gray	25
8227140	Needle electrodes, mixture 1 includes 5 red, 5 blue, 5 green, 5 white, 5 yellow	25

# Electrodes: recording

## Subdermal needle twisted pair electrode set

- Packaged with one green and one white subdermal electrode
- Sterile, single use

Product	Description	Qty
8227421	4-channel, 22 mm	1 set
8227422	8-channel, 22 mm	1 set



## Paired subdermal electrodes

- Packaged with one green and one white subdermal electrode
- Sterile, single use

Product	Description	Qty
8227410	2-channel, 12 mm	1 set
8227411	4-channel, 12 mm	1 set
8227412	8-channel, 12 mm	1 set
8227465	Mix 1: red, blue, orange, violet, gray	25
8227466	Mix 2: yellow, green, tan, black, white	25

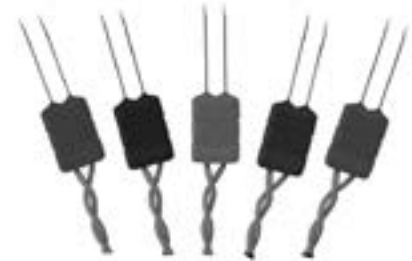

## Prass paired electrodes

- Packaged with one green and one white subdermal electrode
- Sterile, single use

Product	Description	Qty
8227304	2-channel, 18 mm, 1 M cable	5 sets
8227301	2-channel, 25 mm, 1 M cable	5 sets
8227307	2-channel, 38 mm, 1 M cable	5 sets
8227500	4-channel, 18 mm, 2 M cable	1 set
8227505	4-channel, 25 mm, 2 M cable	1 set
8227510	2-channel, 18 mm, 2 M cable	5 sets



## Prass paired electrodes with small hub

- Sterile, single use

Product	Description	Qty
8227414	2-channel, 12.5 mm	5 sets
8227415	4-channel, 12.5 mm	5 sets
8227418	2-channel, 18.0 mm	5 sets
8227419	4-channel, 18.0 mm	5 sets

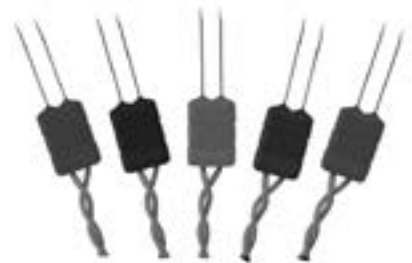

# Nerve locators/stimulators

## Vari-Stim™ III hand-held nerve locator/stimulator

- Battery-powered, single use
- Individual sterile packages

Product	Description	Qty
8562010	Vari-Stim stimulators	10



**Medtronic**

Engineering the extraordinary

ENT product catalog

# PTeye™ parathyroid detection system

# PTeye™ parathyroid detection system

## PTeye™ parathyroid detection system

### System requirements

Item number	Description	Qty
PT102	PTeye™ basic bundle	
PTeye	PTeye™ console	1 ea
PTeye - 2	PTeye™ foot pedal	1 ea
PTeye - 3	PTeye™ power supply	1 ea
PTeye - 4	PTeye™ power cord 125 V (US)	1 ea
PTeye - 1	PTeye™ single-use probe	1 ea



IEC 60825-1 Ed. 3 (2014)

**Medtronic**

Engineering the extraordinary

ENT product catalog

# Ventilation tubes and myringotomy accessories



# Ventilation tubes and myringotomy accessories

## Dimensions

All dimensions are approximate and subject to normal manufacturing variance.

All measurements are listed as millimeters.

ID = inner diameter

IFD = inner flange diameter

OFD = outer flange diameter

IFDis = interflange distance

L = length

FL = flange length

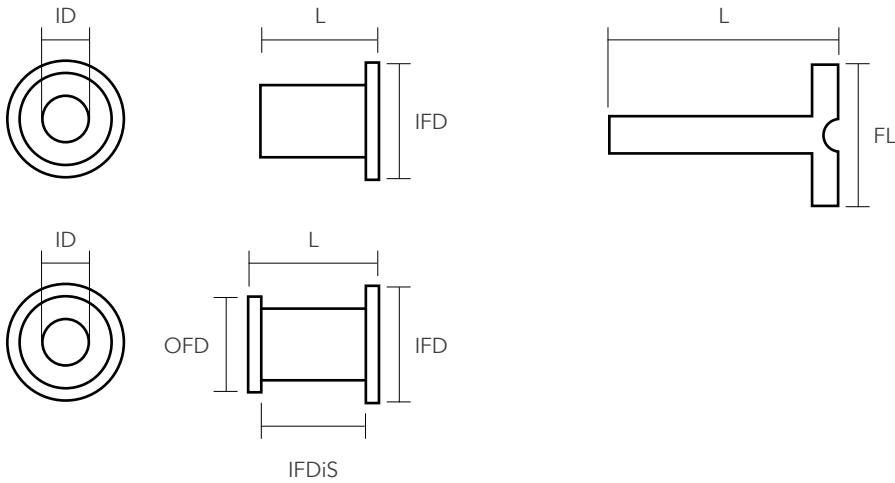

# Ventilation tubes: temporary

## Armstrong beveled grommets

Designed by Beverly W. Armstrong, MD, Charlotte, NC

Material	Feature	Color	RT	Qty	ID	IFD	Product
Microgel™	Tab	Green	INT	5	1.14	3.5	25501
Microgel	Tab	Green	INT	5 pairs	1.14	3.5	25502
FLPL		Green	INT	5	1.14	3.5	1010030
FLPL		Green	INT	50	1.14	3.5	1010031
Silicone		Green	INT	5	1.14	3.5	1010055
Silicone		Green	INT	50	1.14	3.5	1010056
Silicone	Tab	Green	INT	5	1.14	3.5	24502
Firm silicone	Tab	Green	INT	5	1.14	3.5	24501
H/C-Flex™		Sea green	INT	5	1.14	3.5	1056032
H/C-Flex		Sea green	INT	5 pairs	1.14	3.5	1066032
H/C-Flex		Sea green	INT	50	1.14	3.5	1076032



## Armstrong beveled grommets, modified

Designed by Beverly W. Armstrong, MD, Charlotte, NC

Material	Color	RT	Qty	ID	IFD	Product
Microgel™	Blue	INT	5	1.14	3.5	1081101
FLPL	Green	INT	5	1.14	3.5	1010170
FLPL	Green	INT	5 pairs	1.14	3.5	1040045
FLPL	Green	INT	50	1.14	3.5	1010171
FLPL	White	INT	5	1.14	3.5	1014242
FLPL	White	INT	5 pairs	1.14	3.5	1040024
FLPL	White	INT	50	1.14	3.5	1014243
FLPL	White	INT	5	1.14	3.5	14421



## Armstrong beveled straight shanks

Designed by Beverly W. Armstrong, MD, Charlotte, NC

Material	Color	RT	Qty	ID	IFD	L	Product
FLPL	Green	ST	5	1.14	2.50	7.00	1010000
Silicone	Green	ST	5	1.14	2.50	7.00	1010040



RT = residence time, ST = short term (IFD of 0.0-3.0), INT = intermediate (IFD of 3.1-4.8), LT = long term (IFD of > 4.8)

# Ventilation tubes: temporary

## Armstrong v grommets

Designed by Beverly W. Armstrong, MD, Charlotte, NC

Material	Color	RT	Qty	ID	IFD	Product
H/C-Flex™	Sea green	ST	5	1.14	2.1	1056033
H/C-Flex	Sea green	ST	5 pairs	1.14	2.1	1066033



## Armstrong v tubes

Designed by Beverly W. Armstrong, MD, Charlotte, NC

Material	Color	RT	Qty	ID	L	Product
FLPL	White	INT	5	1.14	4.50	1056121
FLPL	White	INT	5 pairs	1.14	4.50	1066121
H/C Flex™	Sea green	INT	5	1.14	4.50	1056031



## Baxter beveled buttons

Designed by David Baxter, RN, Boston, MA

Material	Color	RT	Qty	ID	IFD	L	Product
FLPL	White	ST	5	0.97	2.3	1.6	14621
FLPL	White	INT	5 pairs	1.27	3.0	2.1	14612



## Baxter beveled T-grommets

Designed by David Baxter, RN, Boston, MA

Material	Color	RT	Qty	ID	FL	L	Product
Firm silicone	Green	LT	5	1.27	9.5	3.0	24651
Firm silicone	Green	LT	5 pairs	1.27	9.5	3.0	24652



## Beveled bobbins

Material	Color	RT	Qty	ID	Product
FLPL	White	ST	5	1.14	1056179



RT = residence time, ST = short term (IFD of 0.0-3.0), INT = intermediate (IFD of 3.1-4.8), LT = long term (IFD of > 4.8)

# Ventilation tubes: temporary

## Cohen T-grommets

Designed by Richard Cohen, MD, Grants Pass, OR

Material	Color	RT	Qty	ID	FL	Product
Firm silicone	Green	LT	5	1.14	9.1	24701



## Donaldson-type tubes

Material	Feature	Color	RT	Qty	ID	IFD	IFDis	Product
FLPL		Blue	ST	5	1.14	2.3	0.90	1015101
Silicone		Green	ST	5	1.14	2.3	0.90	1013020
Silicone		Green	ST	50	1.14	2.3	0.90	1013021
Silicone	Tab	Green	ST	5	1.14	2.3	0.90	1013015
C-Flex™		Sea green	ST	5	1.14	2.3	0.76	1056010

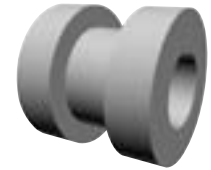

## Goode T-grommets

Endorsed by Richard L. Goode, MD, Palo Alto, CA

Material	Color	RT	Qty	ID	FL	IFDis	Product
Silicone	Green	LT	5	1.27	8.5	2.50	1016020



## Goode T-Tubes™

Designed by Richard L. Goode, MD, Palo Alto, CA

Material	Color	RT	Qty	ID	FL	L	Product
Microgel™ silicone	Blue	LT	5	1.14	9.8	12.0	1087701
Silicone	Green	LT	5	1.14	9.5	12.0	1016010
Silicone	Green	LT	5 pairs	1.14	9.5	12.0	1040001
Silicone	Green	LT	50	1.14	9.5	12.0	1016011
Firm silicone	Green	LT	5	1.14	6.0	6.0	24751
Firm silicone	Green	LT	5 pairs	1.14	6.0	6.0	24752
Firm silicone	Green	LT	5	1.14	9.5	12.0	1016035
C-Flex™	Sea green	LT	5	1.14	6.5	6.0	1056016
C-Flex	Sea green	LT	5	1.14	8.0	9.0	1056019
C-Flex	Sea green	LT	5	1.14	9.0	12.0	1056015



RT = residence time, ST = short term (IFD of 0.0-3.0), INT = intermediate (IFD of 3.1-4.8), LT = long term (IFD of > 4.8)

# Ventilation tubes: temporary

## Goode T-Tubes, modified

Material	Color	RT	Qty	ID	FL	L	Product
Silicone	Green	LT	5	1.27	5.8	6.7	24771
Silicone	Green	LT	5 pairs	1.27	5.8	6.7	24772
Firm silicone	Green	LT	5	1.27	9.5	4.5	1016040
Firm silicone	Green	LT	5 pairs	1.27	9.5	4.5	1040002



## Hubbard airplane tube

Endorsed by Ron Hubbard, MD, Memphis, TN; acknowledgement to Joseph B. Touma, MD, Huntington, WV

Material	Color	RT	Qty	ID	OFD	Product
FLPL	White	ST	5	0.76	2.0	1056170



## Moretz tab vent tubes

Endorsed by William H. Moretz, Jr., MD, Augusta, GA

Material	Color	RT	Qty	ID	IFDis	Product
FLPL	White	ST	5	1.27	1.00	1056177
FLPL	White	ST	5 pairs	1.27	1.00	1066177
Microblue titanium	Microblue	ST	5 pairs	1.27	1.00	14642
Tytan™ titanium	Titanium	ST	5	0.76	1.00	1056108
Tytan titanium	Titanium	ST	5	1.02	1.00	1056104
Tytan titanium	Titanium	ST	5	1.27	1.00	1056107
Tytan titanium	Titanium	ST	5 pairs	1.27	1.00	1066107
H/C-Flex™	Sea green	ST	5	1.27	0.75	1056705



RT = residence time, ST = short term (IFD of 0.0-3.0), INT = intermediate (IFD of 3.1-4.8), LT = long term (IFD of > 4.8)

# Ventilation tubes: temporary

## Paparella-type vent tubes

Designed by Michael M. Paparella, MD, Minneapolis, MN

Material	Feature	Color	RT	Qty	ID	IFD	IFDis	Product
Microgel™	Notch & tab	Green	ST	5	1.02	2.50	1.00	25441
Microgel	Notch & tab	Green	ST	50	1.02	2.50	1.00	25443
Microgel		Blue	INT	5	1.14	–	–	1082201
Microgel		Blue	INT	5 pairs	1.14	–	–	1082202
FLPL	Tab	White	ST	5 pairs	1.02	2.50	1.00	14521
Silicone	Notch & tab	Green	ST	5	1.14	2.40	1.10	1025001
Silicone	Notch & tab	Green	ST	5 pairs	1.14	2.40	1.10	1040006
Silicone	Notch & tab	Green	ST	50	1.14	2.40	1.10	1025002
Silicone	Notch	Green	ST	5	1.14	2.40	1.10	1025005
Silicone	Notch & tab	Green	INT	5	1.52	4.45	1.15	1025045
Firm silicone	Notch & tab	Green	ST	5 pairs	1.02	2.50	1.00	24442
Firm silicone	Notch	Green	ST	5	1.02	2.50	1.00	24451
Firm silicone	Notch	Green	ST	5 pairs	1.02	2.50	1.00	24452
C-Flex™	Tab	Sea green	ST	5	1.02	2.50	1.00	1056005
C-Flex	Tab	Sea green	ST	5 pairs	1.02	2.50	1.00	1066005

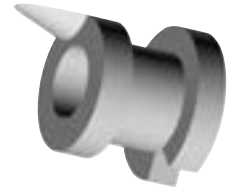

## Plain straight shanks

Material	Color	RT	Qty	ID	IFD	L	Product
FLPL	White	ST	5	1.14	2.10	7.00	1056167
FLPL	White	ST	5	1.14	2.30	12.00	14351



## Pope beveled grommets

Designed by Thad Pope, MD, Crawfordsville, IN

Material	Feature	Color	RT	Qty	ID	IFD	IFDis	Product
FLPL		Green	INT	5	1.14	3.6	1.3	1025004
FLPL		Green	INT	5 pairs	1.14	3.6	1.3	1040014
FLPL	Dispenser	Green	INT	50	1.14	3.6	1.3	1025007
H/C-Flex		Sea green	INT	5 pairs	1.14	3.6	1.0	1066036
H/C-Flex	Tail	Sea green	INT	5 pairs	1.14	3.6	1.0	1066039



RT = residence time, ST = short term (IFD of 0.0-3.0), INT = intermediate (IFD of 3.1-4.8), LT = long term (IFD of > 4.8)

# Ventilation tubes: temporary

## Reuter bobbins

Designed by S. Harold Reuter, MD, Houston, TX

Material	Feature	Color	RT	Qty	ID	IFD	IFDis	Product
FLPL	No holes	White	ST	5	1.02	2.6	1.0	1056162
FLPL	No holes	White	ST	5	1.02	2.7	1.1	14121
FLPL	No holes	White	ST	5 pairs	1.02	2.7	1.1	14122
FLPL	No holes	White	ST	5	1.14	2.7	1.1	14131
FLPL	No holes	Blue	ST	5	1.14	2.6	1.0	1010201
FLPL	No holes	Blue	ST	5 pairs	1.14	2.6	1.0	1010202
FLPL	No holes	Blue	ST	50	1.14	2.6	1.0	1010203
FLPL	Holes & wire	Blue	ST	5	1.14	2.6	1.0	1010301
Titanium	Holes	Titanium	ST	5	1.14	2.6	1.0	1027060
Titanium	No holes	Titanium	ST	5	1.27	2.6	1.0	1027070
Stainless steel matte finish	Holes	Steel	ST	5 pairs	1.14	2.6	1.0	1040004
Stainless steel	Holes	Steel	ST	5	1.02	2.7	1.0	14401
Stainless steel	Holes & wire	Steel	ST	5	1.14	2.6	1.0	1027040
Stainless steel	Holes	Steel	ST	5	1.14	2.6	1.0	1027015
Stainless steel		Steel	ST	50	1.14	2.6	1.0	1027016
Stainless steel	Holes	Steel	ST	5	1.27	2.6	0.5	1027010
Stainless steel	Holes	Steel	ST	5	1.27	2.7	1.0	14051



## Rube T-grommet

Designed by William Rubenstein, MD, Houston, TX

Material	Feature	Color	RT	Qty	ID	FL	Product
Firm silicone	Tab	Green	LT	5	1.14	6.5	24621



## Shah-type ventilation tubes

Designed by N. Shah, FRCS, DLO, London, England

Material	Feature	Color	RT	Qty	ID	IFDis	Product
FLPL	Mini	White	ST	5	0.76	1.00	14311
FLPL		Blue	ST	5	1.14	1.58	1018100
FLPL	Wire	Blue	ST	5	1.14	1.58	1018101



RT = residence time, ST = short term (IFD of 0.0-3.0), INT = intermediate (IFD of 3.1-4.8), LT = long term (IFD of > 4.8)

# Ventilation tubes: temporary

## Sheehy-type collar buttons

Designed by James L. Sheehy, MD, Los Angeles, CA

Material	Color	RT	Qty	ID	IFD	IFDis	Product
Microgel™	Blue	ST	5	1.27	2.8	1.32	1083301
Microgel	Blue	ST	5 pairs	1.27	2.8	1.32	1083302
Microgel	Blue	ST	50	1.27	2.8	1.32	1083303
FLPL	White	INT	5	1.27	3.0	1.52	14141
FLPL	White	INT	5 pairs	1.27	3.0	1.52	14142
FLPL	White	INT	5	1.27	3.1	1.50	1056160
FLPL	Blue	INT	5	1.27	3.0	1.55	1013301
FLPL	Blue	INT	5 pairs	1.27	3.0	1.55	1013302
FLPL	Blue	INT	50	1.27	3.0	1.55	1013303
Silicone	Green	ST	5	1.27	2.8	1.32	1028145
Silicone	Green	ST	50	1.27	2.8	1.32	1028146
Tytan™ titanium	Titanium	INT	5	1.27	3.1	1.50	1056114
H/C-Flex™	Sea green	INT	5	1.27	3.1	1.50	1056037
H/C-Flex	Sea green	INT	5 pairs	1.27	3.1	1.50	1066037



## Shepard grommets

Designed by Marvin G. Shepard, MD, Dallas, TX

Material	Feature	Color	RT	Qty	ID	IFD	Product
FLPL		White	ST	5	1.02	2.50	1056155
FLPL		White	ST	5	1.14	2.50	1056154
FLPL	Wire	White	ST	5	1.14	2.50	1056157
FLPL		Blue	ST	5	1.02	2.40	1016301
FLPL	Wire	Blue	ST	5	1.02	2.40	1016501
FLPL		Blue	ST	5 pairs	1.14	2.40	1016102
FLPL	Wire	Blue	ST	5	1.14	2.40	1016201
FLPL	Wire	Blue	ST	50	1.14	2.40	1016203
FLPL	Tab	Blue	ST	5	1.14	2.40	1016101
FLPL	Tab	Blue	ST	50	1.14	2.40	1016103
FLPL	Tail	Green	ST	5	1.14	2.40	1028010
FLPL	Tab	Green	ST	5	1.14	2.40	1028015
Silicone	Tail	Green	ST	5	1.14	2.30	1028025
Silicone	Tail	Green	ST	50	1.14	2.30	1028026



RT = residence time, ST = short term (IFD of 0.0-3.0), INT = intermediate (IFD of 3.1-4.8), LT = long term (IFD of > 4.8)



# Ventilation tubes: temporary

## Soileau Tytan™ titanium ventilation tubes

Endorsed by James S. Soileau, MD, Gonzales, LA

Material	Color	RT	Qty	ID	IFD	Product
Tytan™ titanium	Titanium	ST	5	1.27	2.75	1056111
Tytan titanium	Titanium	ST	5 pairs	1.27	2.75	1066111



## Spoon bobbins

Material	Feature	Color	RT	Qty	ID	IFD	Product
Tytan™ titanium		Titanium	ST	5	1.02	2.70	1056109
Tytan titanium		Titanium	ST	5	1.27	2.70	1056106
Stainless steel	Holes	Steel	ST	5 pairs	1.02	2.70	14002



## Touma T-type grommets

Endorsed by Joseph B. Touma, MD, Huntington, WV

Material	Color	RT	Qty	ID	IFD	Product
C-Flex™	Sea green	INT	5	1.14	5.0	1056012
C-Flex	Sea green	INT	5 pairs	1.14	5.0	1066012



## T-type vent tubes

Material	Color	RT	Qty	ID	FL	L	Product
C-Flex™	Sea Green	INT	5	1.14	4.8	6	1056018



## Umbrella ventilation tubes

Material	Feature	Color	RT	Qty	ID	IFD	Product
Silicone	Tab	Green	INT	5	1.02	2.26	1016030



RT = residence time, ST = short term (IFD of 0.0-3.0), INT = intermediate (IFD of 3.1-4.8), LT = long term (IFD of > 4.8)

# Ventilation tubes: temporary

## Venturi™ style ventilation tubes

Material	Feature	Color	RT	Qty	ID	IFD	IFDis	Product
Titanium	Reuter bobbin	Titanium	ST	5	1.27	2.5	1.0	1070031
Titanium	Reuter bobbin	Titanium	ST	5 pairs	1.27	2.5	1.0	1070032



## V-T grommet ventilation tubes

Material	Color	RT	Qty	ID	IFD	IFDis	Product
Microgel™	Blue	INT	5	1.27	4.5	1.3	1084401
C-Flex™	Sea green	INT	5	1.27	4.5	1.3	1002341



RT = residence time, ST = short term (IFD of 0.0-3.0), INT = intermediate (IFD of 3.1-4.8), LT = long term (IFD of > 4.8)

# Ventilation tubes: permanent and specialty

## Hoffman permanent vent tubes

Material	Feature	Color	RT	Qty	ID	L	Product
FLPL		White	P	5	1.25	13.4	1028081



## Silverstein permanent aeration tubes (SPAT)

Endorsed by Herbert Silverstein, MD, Sarasota, FL

Material	Feature	Color	RT	Qty	ID	FL	L	Product
Silicone	FLPL stylet	Blue and White	P	5	1.14	3.5	12	1028065



## Pediatric ventilation tubes

1056101, 1056102, and 1056159 Endorsed by M. Coyle Shea, MD, Memphis, TN

1056108 Endorsed by William H. Moretz, Jr., MD, Augusta, GA

Feature	Material	Color	RT	Qty	ID	IFD	Product
	Microblue™ Titanium	Microblue	ST	5	0.76	2.0	16191
	Tiny Tytan™ Titanium	Titanium	ST	5	0.76	1.5	1056101
	Tytan Titanium	Titanium	ST	5	0.76	2.0	1056102
Moretz tab	Tiny Tytan Titanium	Titanium	ST	5	0.76	1.5	1056108
Mini shah	FLPL	White	ST	5	0.76	2.0	14311
	FLPL	White	ST	5	0.76	2.0	1056159
	FLPL	White	ST	5 pairs	0.76	2.0	1066159



## Tympanic Membrane™ patcher

Product	Description	Dia	Core Dia	Qty
1416000	Silicone	3 mm	0.9 mm	1
1416010	Silicone	5 mm	1.1 mm	1
1416020	Silicone	7 mm	1.3 mm	1
1416030	Silicone	10 mm	1.4 mm	1



RT = residence time, ST = short term (IFD of 0.0-3.0), INT = intermediate (IFD of 3.1-4.8), LT = long term (IFD of > 4.8), P = permanent

**Medtronic**

Engineering the extraordinary

ENT product catalog

# Ossicular reconstruction implants and accessories

# Stapedectomy/stapedotomy implants: pistons

## The Big Easy™ piston

- Double-width platinum shaft
- Titanium body
- Depth marker
- Offset piston with angled shaft
- Right and left versions

Product	Description	SD	SL	L	Qty
1156601	Straight, platinum and titanium	0.5 mm	1.25 mm	4.00 mm	1
1156602	Straight, platinum and titanium	0.5 mm	1.25 mm	4.25 mm	1
1156603	Straight, platinum and titanium	0.5 mm	1.25 mm	4.50 mm	1
1156604	Straight, platinum and titanium	0.5 mm	1.25 mm	4.75 mm	1
1156611	Left ear offset, platinum and titanium	0.5 mm	1.25 mm	4.50 mm	1
1156612	Left ear offset, platinum and titanium	0.5 mm	1.25 mm	4.75 mm	1
1156613	Left ear offset, platinum and titanium	0.5 mm	1.25 mm	5.00 mm	1
1156621	Right ear offset, platinum and titanium	0.5 mm	1.25 mm	4.50 mm	1
1156622	Right ear offset, platinum and titanium	0.5 mm	1.25 mm	4.75 mm	1
1156623	Right ear offset, platinum and titanium	0.5 mm	1.25 mm	5.00 mm	1



## Causse loop pistons

Endorsed by Jean-Bernard Causse, MD, Béziers, France

Product	Description	LID	SD	L	Qty
1156314	Fluoroplastic	0.6 mm	0.4 mm	6.0 mm	1
1156316	Fluoroplastic	0.6 mm	0.6 mm	6.0 mm	1



All dimensions are approximate.

LID = loop inner diameter    SD = shaft diameter    SL = shaft length    L = length

# Stapedectomy/stapedotomy implants: pistons

## Cause large loop pistons

- Larger loop inside diameter of 0.8 mm

Endorsed by Jean-Bernard Causse, MD, Béziers, France

Product	Description	LID	SD	L	Qty
1129015	Fluoroplastic	0.80 mm	0.3 mm	4.5 mm	1
1129020	Fluoroplastic	0.80 mm	0.3 mm	5.0 mm	1
1129030	Fluoroplastic	0.80 mm	0.3 mm	6.0 mm	1
1156241	Fluoroplastic	0.80 mm	0.4 mm	6.0 mm	1
1129040	Fluoroplastic	0.80 mm	0.6 mm	4.0 mm	1
1129045	Fluoroplastic	0.80 mm	0.6 mm	4.5 mm	1
1129050	Fluoroplastic	0.80 mm	0.6 mm	5.0 mm	1
1129055	Fluoroplastic	0.80 mm	0.6 mm	6.0 mm	1



## Cause malleus loop with malleable shaft

- Stainless steel core
- Opening in loop at 2 o'clock position

Endorsed by Jean-Bernard Causse, MD, Béziers, France

Product	Description	LID	SD	L	Qty
1133191	Fluoroplastic and stainless steel	0.86 mm	0.4 mm	12 mm	1

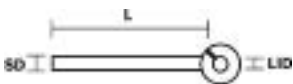

All dimensions are approximate.

LID = loop inner diameter    SD = shaft diameter    SL = shaft length    L = length

# Stapedectomy/stapedotomy implants: pistons

## Lesinski platinum and fluoroplastic stapedotomy pistons

Endorsed by S. George Lesinski, MD, Cincinnati, OH

Product	Description	SD	SL	L	Qty
0427	Platinum and fluoroplastic	0.6 mm	2.0 mm	4.25 mm	1
0428	Platinum and fluoroplastic	0.6 mm	2.0 mm	4.50 mm	1
0429	Platinum and fluoroplastic	0.6 mm	2.0 mm	4.75 mm	1



## Mcgee modified loop pistons

- Round loop design with closure tab
- One piece, stainless steel

Endorsed by T. Manford McGee, MD, Detroit, MI

Product	Description	SD	SL	L	Qty
1156210	Stainless steel	0.5 mm	2.43 mm	3.75 mm	1
1156212	Stainless steel	0.5 mm	2.43 mm	4.25 mm	1
1156213	Stainless steel	0.5 mm	2.43 mm	4.50 mm	1
1156214	Stainless steel	0.5 mm	2.43 mm	4.75 mm	1



## Portmann piston – clip

- Curved wire clip

Endorsed by Professor Michel Portmann, Bordeaux, France

Product	Description	SD	SL	L	Clip	Qty
1125025	Stainless steel and fluoroplastic	0.4 mm	4.00 mm	7 mm	0.6 mm	1

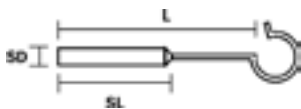

All dimensions are approximate.

SD = shaft diameter    SL = shaft length    L = length

# Stapedectomy/stapedotomy implants: pistons

## Scheer piston and wire

- Fluoroplastic piston, stainless steel wire

Endorsed by Harold F. Schuknecht, MD

Product	Description	SD	SL	L	Qty
1128190	Stainless steel and fluoroplastic	0.6 mm	1.8 mm	5.0 mm	1



## Schuknecht-type piston and wire

- Fluoroplastic piston, stainless steel wire

Endorsed by Harold F. Schuknecht, MD

Product	Description	SD	SL	L	Qty
1128110	Stainless steel and fluoroplastic	0.6 mm	2.7 mm	3.50 mm	1
1128120	Stainless steel and fluoroplastic	0.6 mm	2.7 mm	4.00 mm	1
1128125	Stainless steel and fluoroplastic	0.6 mm	2.7 mm	4.25 mm	1
1128130	Stainless steel and fluoroplastic	0.6 mm	2.7 mm	4.50 mm	1
1128135	Stainless steel and fluoroplastic	0.6 mm	2.7 mm	4.75 mm	1
1128140	Stainless steel and fluoroplastic	0.6 mm	2.7 mm	5.00 mm	1

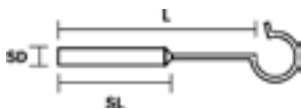

All dimensions are approximate.

SD = shaft diameter    SL = shaft length    L = length



# Stapedectomy/stapedotomy implants: cupped pistons

## Bailey/Pappas modified cupped pistons

- Designed with no hole in shaft
- Polished stainless steel

Endorsed by H. A. Ted Bailey, MD, and James J. Pappas, MD, Little Rock, AR

Product	Description	SD	WD	L	Qty
1156452	Stainless steel	0.4 mm	1 mm	4.00 mm	1
1156453	Stainless steel	0.4 mm	1 mm	4.25 mm	1
1156454	Stainless steel	0.4 mm	1 mm	4.50 mm	1

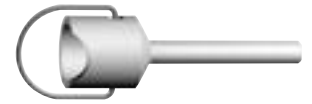

## Lippy modified cupped pistons

- Large, deep well
- Polished stainless steel

Endorsed by William N. Lippy, MD, Warren, OH

Product	Description	SD	WD	L	FL	Qty
1133250	Stainless steel	0.6 mm	1 mm	4.0 mm	3.20 mm	1
1133255	Stainless steel	0.6 mm	1 mm	4.5 mm	3.70 mm	1
1133280	Stainless steel	0.4 mm	1 mm	4.0 mm	3.20 mm	1
1133285	Stainless steel	0.4 mm	1 mm	4.5 mm	3.70 mm	1
1133290	Stainless steel	0.4 mm	1 mm	5.0 mm	4.20 mm	1



## Roberson stapes prostheses

- Narrow design and malleable shaft
- Textured bucket surface
- Piston depth gauge

Endorsed by Joseph Roberson Jr., MD, Palo Alto, CA

Product	Description	SD	WD	FL	Qty
1133061	Titanium	0.6 mm	0.9 mm	4.00 mm	1
1133063	Titanium	0.6 mm	1.0 mm	4.00 mm	1
1133064	Titanium	0.6 mm	1.0 mm	4.50 mm	1
1133065	Titanium	0.6 mm	0.9 mm	4.25 mm	1
1133066	Titanium	0.6 mm	1.0 mm	4.25 mm	1



All dimensions are approximate.

SD = shaft diameter    WD = well diameter    L = length    FL = functional length

# Stapedectomy/stapedotomy implants: cupped pistons

## Robinson™ cupped pistons

- Cupped piston design
- Polished stainless steel, matte finish well

Endorsed by Mendell Robinson, MD, Providence, RI

Product	Description	SD	WD	FL	Qty
1133001	Stainless steel	0.6 mm	0.9 mm	4.0 mm	1
1133002	Stainless steel	0.6 mm	0.9 mm	4.5 mm	1
1133003	Stainless steel	0.6 mm	1.0 mm	4.0 mm	1
1133004	Stainless steel	0.6 mm	1.0 mm	4.5 mm	1
1133005	Stainless steel	0.4 mm	0.9 mm	4.0mm	1
1133007	Stainless steel	0.4 mm	1.0 mm	4.0 mm	1
1133008	Stainless steel	0.4 mm	1.0 mm	4.5 mm	1



## Robinson™-Moon-Lippy offset cupped pistons

- Offset shaft
- Large, deep well
- Fenestrated
- Polished stainless steel, matte finish well

Endorsed by Mendell Robinson, MD, Providence, RI; Cary N. Moon, Jr., MD; and William N. Lippy, MD, Warren, OH

Product	Description	SD	WD	L	FL	Qty
1133009	Stainless steel	0.4 mm	1 mm	4.5 mm	3.73 mm	1



All dimensions are approximate.

SD = shaft diameter    WD = well diameter    L = length    FL = functional length

# Universal ossicular reconstruction implants: titanium

## Universal titanium prostheses

- The universal titanium prosthesis is available in two head designs
- Fenestrated head
- The titanium shaft may be trimmed to length with scissors
- Universal design

Product	Description	Qty
1150000	Universal titanium prosthesis, round head, with shoe	1
1150001	Universal titanium prosthesis, cam head, with shoe	1



## Universal titanium prosthesis, vincent head, with shoe

- Dense hydroxylapatite head features a deep, centered groove
- The titanium shaft may be trimmed to length with scissors
- Universal design
- Shoe packaged as a partial; may be trimmed to create a total shoe

Designed by Robert Vincent, MD, Béziers, France

Product	Description	PID	HD	SD	L	Qty
1150050	Titanium and hydroxylapatite head/shaft assembly titanium and Flex H/A shoe assembly	1.1 mm	3.25 mm	0.25 mm	10 mm	1



All dimensions are approximate.

PID = partial inner diameter    HD = head diameter    SD = shaft diameter    L = length

# Partial ossicular reconstruction implants: titanium

## Partial titanium prosthesis

- Fully cannulated design

Product	Description	HD	L	ID	Qty
1160000	Titanium	2.5 mm	2 mm	1.1 mm	1



## Vincent partial titanium prosthesis

- Dense hydroxylapatite head features a deep, centered groove

Developed in conjunction with Robert Vincent, MD, Béziers, France

Product	Description	HD	L	ID	Qty
1160050	Titanium	3.25 mm	2 mm	1.1 mm	1

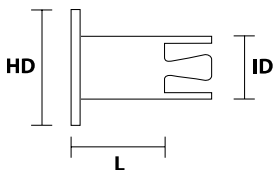

All dimensions are approximate.

HD = head diameter    L = length    ID = inner diameter

# Partial ossicular reconstruction implants: dense hydroxylapatite

## Incus partial prosthesis

- Grooved top
- Partially cannulated shaft

Product	Description	SID	L	Qty
1112075	Hydroxylapatite	1.1 mm	3.75 mm	1



## Notched offset partial

- Dense H/A cap
- Offset cap

Product	Description	SID	HD	L	Qty
0362	Hydroxylapatite	1.14 mm	4 mm	5 mm	1
0364	with malleable link, hydroxylapatite with titanium	1.14 mm	4 mm	5 mm	1

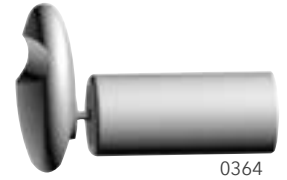

## Partial 75° rectangular

- Rectangular head
- Angled shaft
- Partially cannulated shaft

Product	Description	SID	H	L	Qty
1112070	Hydroxylapatite	1.1 mm	2.5 x 3.5 mm	4 mm	1



## Partial 90° off-center round

- Off-centered round head
- Fully cannulated shaft

Product	Description	SID	HD	L	Qty
1112095	Hydroxylapatite	1.1 mm	4 mm	5 mm	1



All dimensions are approximate.

SID = shaft inner diameter    H = head    HD = head diameter    L = length

# Partial ossicular reconstruction implants: dense hydroxylapatite

## Partial 90° rectangular

- Rectangular head
- Partially cannulated shaft

Product	Description	SID	H	L	Qty
1112065	Hydroxylapatite	1.1 mm	2.5 x 3.5 mm	4 mm	1

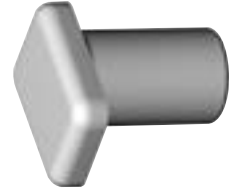

## Partial 90° round

- Round head
- Fully cannulated shaft

Product	Description	SID	HD	L	Qty
1112090	Hydroxylapatite	1.1 mm	4 mm	5 mm	1

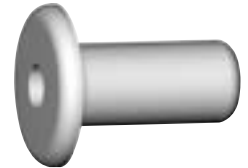

All dimensions are approximate.

SID = shaft inner diameter    H = head    HD = head diameter    L = length

# Partial ossicular reconstruction implants: Flex H/A

## Silverstein incus-stapes connector

Endorsed by Herbert Silverstein, MD, Sarasota, FL

Product	Description	ID	OD	H	Qty
1112120	Hydroxylapatite	1.1 mm	2.1 mm	1 mm	1



## Cause mini-head partial with malleable link

- Flex H/A shaft may be trimmed with a knife

Endorsed by Jean-Bernard Cause, MD, Béziers, France

Product	Description	SID	HD	L	Qty
0528	Hydroxylapatite with Flex H/A and titanium	1.14 mm	2.5 mm	5 mm	1



## Cause notched offset partial with malleable link

- Offset, dense H/A cap with notch
- Flex H/A shaft may be trimmed with a knife
- Malleable titanium link

Endorsed by Jean-Bernard Cause, MD, Béziers, France

Product	Description	SID	HD	L	Qty
0526	Hydroxylapatite with Flex H/A and titanium	1.14 mm	3.25 mm	5 mm	1



## Cause-vincent notched narrow partial with short malleable link

- Offset, dense H/A cap with notch
- Flex H/A shaft may be trimmed with a knife
- Malleable titanium link

Endorsed by Jean-Bernard Cause, MD, and Robert Vincent, MD, Béziers, France

Product	Description	SID	HD	L	Qty
0543	Hydroxylapatite with Flex H/A and titanium	1.14 mm	3.25 mm	14 mm	1



All dimensions are approximate.

ID = inner diameter    OD = outer diameter    SID = shaft inner diameter    H = head    HD = head diameter    L = length

# Partial ossicular reconstruction implants: Flex H/A

## Centered partial with malleable link

- Gently rounded, dense H/A cap
- Flex H/A shaft can be trimmed

Product	Description	SID	HD	L	Qty
0550	Hydroxylapatite with Flex H/A and titanium	1.14 mm	4 mm	5 mm	1
0551	Hydroxylapatite with Flex H/A and titanium	1.14 mm	3 mm	5 mm	1

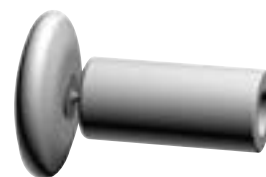

## Centered partial, non-malleable

- Prosthesis is fully cannulated
- Flex H/A shaft may be trimmed with a knife

Product	Description	SID	HD	L	Qty
0524	Hydroxylapatite and Flex H/A	1.14 mm	3 mm	5 mm	1



## Lesinski offset partial with malleable link

- H/A cap features unique notch
- Flex H/A shaft may be trimmed with a knife

Designed by S. George Lesinski, MD, Cincinnati, OH

Product	Description	SID	HD	L	Qty
0531	Hydroxylapatite with Flex H/A and titanium	1.14 mm	3.25 mm	5 mm	1



## Malleus cradle partial with malleable link

- Dense H/A cap
- Titanium link
- Trimmable Flex H/A shaft

Product	Description	SID	H	L	Qty
0541	Hydroxylapatite with Flex H/A and titanium	1.14 mm	2 x 4.4 mm	5 mm	1



All dimensions are approximate.

SID = shaft inner diameter    H = head    HD = head diameter    L = length



# Partial ossicular reconstruction implants: Flex H/A

## Millen thin head partials, non-malleable

- Thin, dense Flex H/A offset cap
- Fully cannulated
- Flex H/A shaft may be trimmed

Designed by Steven J. Millen, MD, Hales Corner, WI

Product	Description	SID	HD	L	Qty
0568	Offset, notched hydroxylapatite and Flex H/A	1.14 mm	4 mm	5 mm	1
0567	Hydroxylapatite and Flex H/A	1.14 mm	4 mm	5 mm	1

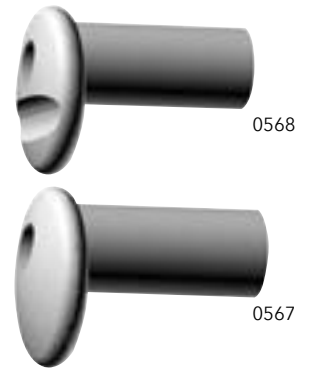

## Notched offset partial with malleable link

- Dense H/A cap
- Cap is offset
- Trimmable Flex H/A shaft

Product	Description	SID	HD	L	Qty
0570	Hydroxylapatite with Flex H/A and titanium	1.14 mm	4 mm	5 mm	1



All dimensions are approximate.

SID = shaft inner diameter    H = head    HD = head diameter    L = length

# Partial ossicular reconstruction implants: Flex H/A™ necrosis

## Cause tri-axial incus necrosis prosthesis

- Dense H/A offset cap and Flex H/A

Developed by Jean-Bernard Causse, MD, Béziers, France

Product	Description	IID	STID	HD	Qty
0585	Hydroxylapatite with Flex H/A and titanium	0.8 mm	1.17 mm	3.25 mm	1



## Flex H/A incus necrosis prostheses

- Flex H/A material can be modified with knife to accommodate anatomical requirements

Product	Description	IID	STID	Qty
0579	Flex H/A, small	0.8 mm	1.00 mm	1
0580	Flex H/A, medium	0.8 mm	1.17 mm	1
0581	Flex H/A, large	1.0 mm	1.17 mm	1



All dimensions are approximate.

SID = shaft inner diameter    H = head    HD = head diameter    L = length

# Partial ossicular reconstruction implants: H/A combination

## Causse malleus head partial

- Dense H/A head

Endorsed by Jean-Bernard Causse, MD, Béziers, France

Product	Description	SID	H	L	Qty
1112197	Hydroxylapatite with polycel and stainless steel	1.17 mm	4 x 2.1 mm	4.75 mm	1

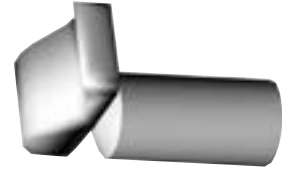

## Moretz cam head partial

- Hydroxylapatite head with polycel and stainless steel
- Cam head design

Endorsed by William H. Moretz, Jr., MD, Augusta, GA

Product	Description	SID	H	L	Qty
1112184	Hydroxylapatite with polycel and stainless steel	1.17 mm	4 x 2.7 mm	10 mm	1



All dimensions are approximate.

SID = shaft inner diameter    H = head    HD = head diameter    L = length

# Partial ossicular reconstruction implants: Polycel™

## Austin modified partial

- Head is off-center
- Fully cannulated

Endorsed by David F. Austin, MD, Idaho Falls, ID

Product	Description	SID	HD	L	Qty
1156361	Polycel	1.17 mm	3 mm	4.75 mm	1



## Cause fluoroplastic partial

- Polycel head
- Fluoroplastic shaft

Endorsed by Jean-Bernard Causse, MD, Béziers, France

Product	Description	SID	HD	L	Qty
1156376	Polycel and Fluoroplastic	1.17 mm	4 mm	4.75 mm	1



## Sheehy partial ossicular prosthesis (POP)

Endorsed by James L. Sheehy, MD, Los Angeles, CA

Product	Description	SID	HD	L	Qty
1156362	Polycel	1.17 mm	3 mm	4.75 mm	1



All dimensions are approximate.

SID = shaft inner diameter    H = head    HD = head diameter    L = length

# Total ossicular reconstruction implants: dense hydroxylapatite

## Cause notched offset total with short malleable link

- Shortened, malleable titanium link
- Notched offset cap
- Dense H/A cap
- Off-set design

Endorsed by Jean-Bernard Causse, MD, Béziers, France

Product	Description	SID	HD	L	Qty
0321	Hydroxylapatite and titanium	0.8 mm	3.25 mm	9 mm	1



## Mushroom head total with malleable link

- Dense hydroxylapatite head

Product	Description	SID	HD	L	Qty
0300	Hydroxylapatite and titanium	0.8 mm	4 mm	7 mm	1



## Notched offset total with malleable link

- Flexible titanium link
- Notched cap
- Offset design

Product	Description	SID	HD	L	Qty
0363	Hydroxylapatite and titanium	0.8 mm	4 mm	7 mm	1



All dimensions are approximate.

SID = shaft inner diameter    H = head    HD = head diameter    L = length

# Total ossicular reconstruction implants: dense hydroxylapatite

## Total 75° rectangular

- Rectangular head
- Solid, dense H/A
- Angled shaft
- May be shaped with diamond bur under irrigation

Product	Description	SID	H	L	Qty
1112050	Hydroxylapatite	0.89 mm	2.54 x 3.5 mm	8 mm	1



## Total 90° rectangular

- Rectangular head
- Solid dense H/A
- May be shaped with diamond bur under irrigation

Product	Description	SID	H	L	Qty
1112045	Hydroxylapatite	0.89 mm	2.54 x 3.5 mm	8 mm	1



All dimensions are approximate.

SID = shaft inner diameter    H = head    L = length

# Total ossicular reconstruction implants: H/A combination

## Total 90° off-center round

- Off-centered round head
- Solid dense H/A
- May be shaped with diamond bur under irrigation

Product	Description	SID	HD	L	Qty
1112085	Hydroxylapatite	0.89 mm	4.00 mm	8 mm	1



All dimensions are approximate.

SID = shaft inner diameter    HD = head diameter    L = length

# Total ossicular reconstruction implants: Flex H/A

## Cause MicroLite™ total with short malleable link

- Thinner cap is notched and offset
- Shortened malleable link allows trimming to short lengths for anatomical variations

Endorsed by Jean-Bernard Causse, MD, Béziers, France

Product	Description	SD	HD	L	Qty
0529	Hydroxylapatite with Flex H/A and titanium	1 mm	3.25 mm	9 mm	1



## Cause notched offset total with short malleable link

- Shortened malleable link allows trimming to short lengths
- Notched, dense H/A cap
- Trimmable Flex H/A shaft

Endorsed by Jean-Bernard Causse, MD, Béziers, France

Product	Description	SD	HD	L	Qty
0518	Hydroxylapatite with Flex H/A and titanium	1 mm	3.25 mm	9 mm	1



All dimensions are approximate.

SID = shaft inner diameter    H = head    HD = head diameter    L = length



# Total ossicular reconstruction implants: Flex H/A

## Causse-Vincent notched narrow cap with stainless steel wire

- Narrow, notched, offset, dense H/A cap
- Trimmable Flex H/A shaft
- Stainless steel wire through shaft

Endorsed by Jean-Bernard Causse, MD, and Robert Vincent, MD, Béziers, France

Product	Description	SD	HD	L	Qty
05421	Hydroxylapatite with Flex H/A & SS wire	1 mm	3.25 mm	9 mm	1



## Centered total with malleable link

- Rounded, dense H/A cap
- Trimmable Flex H/A shaft

Product	Description	SID	HD	L	Qty
0500	Hydroxylapatite with Flex H/A and titanium	1 mm	4 mm	7 mm	1
0501	Hydroxylapatite with Flex H/A and titanium	1 mm	3 mm	7 mm	1



## Centered total, non-malleable

- Dense H/A cap
- Non-malleable shaft, made totally of trimmable Flex H/A

Product	Description	SD	HD	L	Qty
0523	Hydroxylapatite with Flex H/A	1 mm	3 mm	9 mm	1



## Lesinski offset total with malleable link

- Trimmable Flex H/A shaft

Designed by S. George Lesinski, MD, Cincinnati, OH

Product	Description	SD	HD	L	Qty
0530	Hydroxylapatite with Flex H/A and titanium	1 mm	3.25 mm	8 mm	1



All dimensions are approximate.

SID = shaft inner diameter    H = head    HD = head diameter    L = length

# Total ossicular reconstruction implants: Flex H/A

## Malleus cradle total with malleable link

- Dense H/A cap
- Trimmable Flex H/A shaft

Product	Description	SD	H	L	Qty
0540	Hydroxylapatite with Flex H/A and titanium	1 mm	2 x 4.4 mm	10.2 mm	1



## Millen thin head notched total, non-malleable

- Thin, dense Flex H/A offset cap
- Notched head designed
- Trimmable Flex H/A shaft

Designed by Steven J. Millen, MD, Hales Corner, WI

Product	Description	SD	HD	L	Qty
0565	Hydroxylapatite and Flex H/A	1 mm	4 mm	9 mm	1



## Offset total with malleable link

- Dense H/A offset cap and malleable link
- Trimmable Flex H/A shaft

Product	Description	SD	HD	L	Qty
0510	Hydroxylapatite with Flex H/A and titanium	1 mm	4 mm	7 mm	1



## Wiet offset total with malleable link

- Mid-size dense H/A cap
- Malleable titanium link
- Trimmable Flex H/A shaft

Designed by Richard Wiet, MD, Hinsdale, IL

Product	Description	SD	HD	L	Qty
0515	Hydroxylapatite with Flex H/A and titanium	1 mm	3.25 mm	9 mm	1



All dimensions are approximate.

SID = shaft inner diameter    H = head    HD = head diameter    L = length

# Total ossicular reconstruction implants: Polycel™

## Cause stapedotomy revision prosthesis with short malleable link

- Short malleable link allows prosthesis to be trimmed to very short lengths
- Notched H/A cap

Endorsed by Jean-Bernard Causse, MD, Béziers, France

Product	Description	SD	HD	L	Qty
0322	Hydroxylapatite with fluoroplastic and titanium	0.4 mm	3.25 mm	9 mm	1



## Austin modified total

Endorsed by David F. Austin, MD, Idaho Falls, ID

Product	Description	SD	HD	L	Qty
1156305	Polycel and stainless steel	0.6 mm	3 mm	8 mm	1



## Brackmann modified total

Endorsed by Derald E. Brackmann, MD, Los Angeles

Product	Description	SD	HD	L	Qty
1156303	Polycel and stainless steel	0.6 mm	3 mm	8 mm	1



## Sheehy total ossicular prosthesis (TOP)

Endorsed by James L. Sheehy, MD, Los Angeles, CA

Product	Description	SD	HD	L	Qty
1156363	Polycel	0.8 x 1 mm	3 mm	8 mm	1



All dimensions are approximate.

SID = shaft inner diameter    H = head    HD = head diameter    L = length

# Universal ossicular reconstruction implants: Flex H/A

## Bojrab universal prosthesis

Designed by Dennis Bojrab, MD, Farmington Hills, MI

Product	Description	PID	HD	PL	TL	Qty
0506	Hydroxylapatite with Flex H/A shaft	1.14 mm	3 mm	3.65 mm	7 mm	1
0507	Hydroxylapatite with Flex H/A shaft	1.14 mm	3 mm	6.00 mm	9 mm	1



## Convertible prosthesis – total, partial, or strut

- Three-in-one implant: options include total, with or without a footplate, a partial or a strut
- Supplied as a partial with separate insertable total shaft with shoe
- Cap is dense H/A shaft is Flex H/A

Product	Description	PID	HD	PL	TL	Qty
0590	Hydroxylapatite and Flex H/A	1.14 mm	3 mm	5 mm	8 mm	1



## Garcia-Ibanez notched universal prosthesis

- Converts from a total to a partial with a knife

Designed by Emilio Garcia-Ibanez, MD, Barcelona, Spain

Product	Description	PID	H	PL	TL	Qty
0508	Hydroxylapatite, Flex H/A	1.14 mm	3.3 x 2.9 mm	4.25 mm	8 mm	1



All dimensions are approximate.

SID = shaft inner diameter    H = head    HD = head diameter    L = length

# Middle ear liners

## Causse stapes sheet

Endorsed by Jean-Bernard Causse, MD, Béziers, France

Product	Description	L	H	T	Qty
1128450	Fluoroplastic	15 mm	8 mm	.03 mm	1



# Middle ear specialty instruments

## Juhn Tym-Tap™ middle ear fluid aspirator/collector

Designed by S.K. Juhn, MD, Minneapolis, MN

Product	Qty
1419010	10



# Head supports

## Bio-flek™ surgical head supports

Offset design endorsed by William H. Moretz, Jr., MD, Augusta, GA

Product	Size	Qty
1358225	Standard, 50.8 mm x 22.9 cm (2" x 9")	1
1358227	Riser, 25.4 mm x 22.9 cm (1" x 9")	1



**Medtronic**

Engineering the extraordinary

ENT product catalog

# Localized drug delivery



# Localized drug delivery

## PROPEL™ family of sinus implants

Product	Description	Qty
70011	PROPEL mometasone furoate implant	1
700115	PROPEL mometasone furoate implant	5
60011	PROPEL Mini mometasone furoate implant	1
600115	PROPEL Mini mometasone furoate implant	5
50011-	PROPEL Contour mometasone furoate implant	1
50011-5	PROPEL Contour mometasone furoate implant	5
60044-	PROPEL Mini implant with straight delivery system (SDS)	1
60044-5	PROPEL Mini implant with straight delivery system (SDS)	5

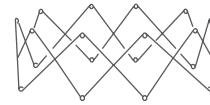
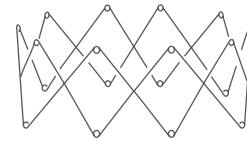

## SINUVA™ (mometasone furoate) sinus implant

NDC number	Descriptor	Qty
10599000301	SINUVA™ (mometasone furoate) 1350mcg	1



### Ordering

SINUVA implants can be obtained through two accessible avenues:

1. Specialty distributor: Providers can purchase SINUVA implants directly from a distributor. Benefits verification and prior authorization from the payer is recommended prior to implanting a patient.
2. Specialty pharmacies: In some cases, SINUVA implants can be filled under the pharmacy benefit by a select specialty pharmacy and delivered directly to the provider. Verifying the patient's benefits will establish the path to fulfillment.

# Localized drug delivery

## SINUVA™ (mometasone furoate) sinus implant

### SINUVA Indication & Important Safety Information

#### INDICATION

SINUVA Sinus Implant is a corticosteroid-eluting (mometasone furoate) implant indicated for the treatment of nasal polyps, in patients  $\geq$  18 years of age who have had ethmoid sinus surgery.

#### IMPORTANT SAFETY INFORMATION

##### CONTRAINDICATIONS

Patients with known hypersensitivity to mometasone furoate and any of the ingredients of the SINUVA should not use SINUVA.

##### WARNINGS AND PRECAUTIONS

**Local effects:** Monitor nasal mucosa adjacent to the SINUVA Sinus Implant for any signs of bleeding (epistaxis), irritation, infection, or perforation. Avoid use in patients with nasal ulcers or trauma.

**Ocular effects:** Monitor patients with a change in vision or with a history of increased intraocular pressure, glaucoma, and/or cataracts closely.

**Hypersensitivity reactions:** Hypersensitivity reactions, including rash, pruritus, and angioedema have been reported with the use of corticosteroids.

**Immunosuppression:** Persons who are using drugs that suppress the immune system are more susceptible to infections than healthy individuals. Corticosteroids should be used with caution, if at all, in patients with active or quiescent tuberculosis infection of the respiratory tract; untreated systemic fungal, bacterial, viral, or parasitic infections; or ocular herpes simplex.

**Hypercorticism and adrenal suppression:** If corticosteroid effects such as hypercorticism and adrenal suppression appear in patients, consider sinus implant removal.

##### ADVERSE REACTIONS

The most common adverse reactions observed ( $>$  1% of subjects and that occurred more frequently in the treatment group compared to control) in clinical studies were asthma, headache, epistaxis, presyncope, bronchitis, otitis media, and nasopharyngitis.

##### POSTMARKETING EXPERIENCE

The following adverse reactions have been identified during post-approval use of the SINUVA sinus implant. These events include implant migration, lack of efficacy, nasal pain, headache, epistaxis.

Rx only. Please see Full Prescribing Information for SINUVA at [www.SINUVA.com/PI](http://www.SINUVA.com/PI)

**Medtronic**

Engineering the extraordinary

ENT product catalog

# Tissue health

# Postoperative dressing

## Chitogel endoscopic sinus surgery kit

- Postoperative sinus gel

Product	Description	Qty
CSK-4	Chitogel endoscopic sinus surgery kit	1



## Novapak™ nasal sinus packing and stent

- A single-use, nasal packing and stent for use following sinus surgery
- Dimensions 8 cm x 1.8 cm x 1.3 cm

Product	Description	Qty
CS3600-2	Novapak nasal packing, 2PK STD	2
CS3900-2	Novapak nasal packing, 2PK FRM	2
CS3600-10	Novapak nasal packing, 10PK STD	10
CS3900-10	Novapak nasal packing, 10PK FRM	10



## MeroGel™ nasal dressing/sinus stent/otologic dressing or packing

- A packing material made from HYAFF™, an esterified form of hyaluronic acid

Product	Description	Qty
1517100	MeroGel otologic packing, 1 cm x 5 cm	1
1517000	MeroGel nasal dressing/sinus stent and otologic packing, 4 cm x 4 cm	1
1517002	MeroGel nasal dressing/sinus stent and otologic packing, 4 cm x 4 cm	2



## MeroPack™ bioresorbable nasal dressing and sinus stent

- A packing material made from HYAFF™, an esterified form of hyaluronic acid and collagen

Product	Description	Qty
1520001	MeroPack bioresorbable nasal dressing and sinus stent	2
1520000	MeroPack bioresorbable nasal dressing and sinus stent	6



# Otologic products

## EpiDisc™ Otologic Lamina

- An otologic device made from HYAFF™, an esterified form of hyaluronic acid
- Pre-cut, 8 mm spherical discs of EpiFilm™ material

Product	Description	Qty
1417100	EpiDisc otologic lamina, 8 mm disc	2



## EpiDisc™ Tympanic Membrane Perforation Patch Kit

- Consists of one 8 mm EpiDisc matrix device and a 2 cm x 2 cm square of MeroGel™ Quick-Gel™ Otologic Dressing, a fast-hydrating form of MeroGel

Product	Description	Qty
1417151	EpiDisc tympanic membrane perforation patch kit	1



## EpiFilm™ Otologic Lamina

- An otologic device made from HYAFF™, an esterified form of hyaluronic acid

Product	Description	Qty
1417000	EpiFilm otologic lamina, 2.5 cm x 2.5 cm	1



# Nasal packing

## Merocel™ Doyle nasal dressing

Product	Description	Length	Thickness	Height	Qty
440411	Without string, with airway	8 cm	1.5 cm	3 cm	10
440411	With string, with airway	8 cm	1.5 cm	3 cm	10
440424	Without string	8 cm	1.5 cm	3 cm	10
440424	With string	8 cm	1.5 cm	3 cm	10
440413	Without string	8 cm	1 cm	3 cm	10
440413	With string	8 cm	1 cm	3 cm	10

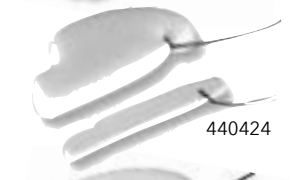

## Merocel™ Doyle nasal dressing, pediatric

Product	Description	Length	Thickness	Height	Qty
440412	Without string	5.5 cm	1.2 cm	2.5 cm	20
440412	With string	5.5 cm	1.2cm	2.5 cm	10



## Merocel™ Kennedy intranasal surgical sponge (KISS) intra-op throat pack

Designed by David Kennedy, MD, Philadelphia, PA

Product	Description	Qty
400515	With string	10



## Merocel™ 2000 nasal packing

Product	Description	Length	Thickness	Height	Qty
470401	With string	4.5 cm	1.5 cm	2 cm	10
470404	With string	8 cm	1.5 cm	2 cm	10
470408	With string, with airway	4.5 cm	1.5 cm	2 cm	10

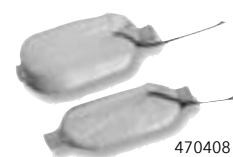
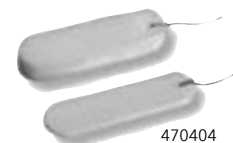
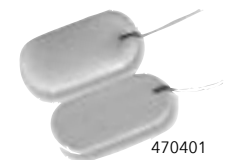

All dimensions are approximate.

# Nasal packing

## Merocel™ standard dressing

Product	Description	Length	Thickness	Height	Qty
400400	Without string	4.5 cm	1.5 cm	2 cm	20
440400	With string	4.5 cm	1.5 cm	2 cm	10
400402	Without string	8 cm	1.5 cm	2 cm	20
440402	With string	8 cm	1.5 cm	2 cm	10
400409	Without string, with airway	4.5 cm	1.5 cm	2 cm	20
440409	With string, with airway	4.5 cm	1.5 cm	2 cm	10
400410	Without string, with airway	8 cm	1.5 cm	2 cm	20
400405	Without string, single compression, with airway	8 cm	1.5 cm	2 cm	20
440410	With string, with airway	8 cm	1.5 cm	2 cm	10

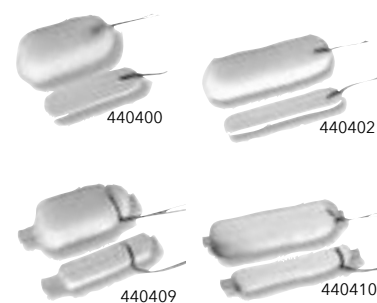

## Merocel™ Pope epistaxis packing

- Available with or without drawstring

Product	Description	Length	Thickness	Height	Qty
400406	Without string	10 cm	1.5 cm	2.5 cm	10
440406	With string	10 cm	1.5 cm	2.5 cm	10



## Merocel™ Pope Flex-Pak™

- Flexible epistaxis packing with pinholes and drawstring

Product	Description	Length	Thickness	Height	Qty
460406	With string	10 cm	1.5 cm	2.5 cm	10



## Merocel™ Staxi-Stat™ pack

Product	Description	Qty
400416	Without string	10
440416	With string	10



## Merocel™ Weimert epistaxis packing

Product	Description	Length	Thickness	Height	Qty
400421	With string	5.5 cm	1.5 cm	2.5 cm	20



All dimensions are approximate.

# Sinus packing

## Merocel™ 2000 Laminated Baron SinuStent™ dressing

Product	Description	Length	Thickness	Height	Qty
470531	With string, ultra-slim profile	2.5 cm	0.6 cm	2 cm	10 pairs



## Merocel™ 2000 Laminated Kennedy SinuStent dressing

Product	Description	Length	Thickness	Height	Qty
470530	With string, ultra-slim profile	3.5 cm	0.6 cm	1.2 cm	10 pairs

## Merocel™ Baron sinus-pak

Product	Description	Length	Thickness	Height	Qty
400407	With string, regular	2.5 cm	1.2 cm	2 cm	10 pairs



## Merocel™ Kennedy sinus-pak

Product	Description	Length	Thickness	Height	Qty
400422	With string, regular	3.5 cm	1.2 cm	1.2 cm	10 pairs
400426	With string, slim-profile	3.5 cm	0.9 cm	1.2 cm	10 pairs
400530	With string, ultra-slim profile	3.5 cm	0.6 cm	1.2 cm	10 pairs

## Merocel Ora-Pak intra-op throat pack

Product	Description	Qty
400520	With string	10



## Merocel™ Toffel sinus-pak kit with airway tube

- Sinus-pak (4.5 cm L x 1.3 cm T x 2.0 cm H)
- Nasal dressing (7.5 cm L x 1.5 cm T x 3.5 cm H)
- Airway tube (8 cm L)

Product	Description	Qty
400423	With string	10 kits



## Merocel™ Toffel slim-profile sinus-pak

Product	Description	Length	Thickness	Height	Qty
400428	Slim-profile	4.5 cm	0.9 cm	2 cm	10 pairs



All dimensions are approximate.



# Ear wicks and packs

## Merocel™ ear packs, ambrus

Product	Diameter	Length	Qty
400354	15 cm	20 cm	20



## Merocel™ micro spheres

Product	Diameter	Thickness	Qty
400150	3 cm	0.7 cm	100
400151	4 cm	0.7 cm	100
400152	5 cm	0.7 cm	100



## Merocel™ ear wicks, pope

Product	Diameter	Length	Qty
400141	9 mm	15 mm	50
425141	9 mm	15 mm	25
400146	9 mm	24 mm	10
400144	12 mm	24 mm	10



## Merocel™ ear packs, post-op

Product	Diameter	Length	Qty
400162	12 mm	24 mm	10



## Merocel™ ear packs, Schindler

Product	Description	Diameter	Length	Qty
400355	With drawstring	12 mm	15 mm	10
400356	With drawstring	9 mm	13 mm	10
400357	With drawstring, fenestrated	9 mm	13 mm	10



## Merocel™ Pope Oto-Wick™

Product	Description	Size	Qty
1425008	Fenestrated	15 mm	50
1425010	Fenestrated	24 mm	50



All dimensions are approximate.

# Epistaxis treatment products

## Medtronic ENT Epistat™ nasal catheter

Product	Description	Qty
1527031	Epistat™ nasal catheter	1



## Tami sinus secretion collector

Developed in conjunction with Thomas A. Tami, MD

Product	Description	Qty
1514000	Sinus secretion collector	10



All dimensions are approximate.

# Splints

## Boomerang™ turbinate glove and septal splint

Product	Qty
600500	5 pairs



## Oval septal splints

Product	Length	Thickness	Height	Qty
1523000	6.4 cm	1 mm	4.2 cm	5 pairs



## Bridgemaster™ nasal splints

- Articulated nasal splint's flexible aluminum stabilizer adjusts inward
- Segmented foam pads

Product	Description	Qty
600302	Small splint	5
600306	Large splint	5



## Doyle bi-valve septal splint

Product	Qty
1524075	1 pair



## Doyle II intranasal airway splints

Product	Qty
1524050	5 pairs



## External nasal splints

- Thermal customizable splints

Product	Description	Qty
1528110	Single, small	25
1528111	Single, small	5
1528120	Single, medium	25
1528121	Single, medium	5
1528137	Single, large	25
1528138	Single, large	5



All dimensions are approximate.

# Splints

## Goode magne-splint

- Cobalt-Samarium magnets ensure compression
- Medical grade silicone
- Pre-attached string

Designed by Richard L. Goode, MD, Palo Alto, CA

Product	Description	Qty
1516000	Regular	1 pair
1516010	Large	1 pair



## Reuter splint

- Constructed of fluoroplastic
- Pre-punched holes for easier suturing

Designed by S. Harold Reuter, MD, Houston, TX

Product	Description	Qty
1527010	Thin 0.25 mm	5 pairs
1527015	Thick 0.5 mm	5 pairs
1527020	Thick 0.5 mm, no slit	5 pairs
1527025	Thin 0.25 mm, no slit	5 pairs
1527000	Thin 0.25 mm	5 pairs
1527005	Thick 0.5 mm	5 pairs

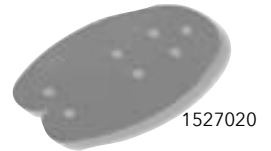
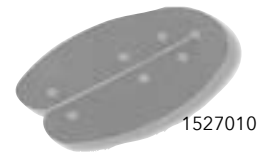

## Merocel™ silicone splint

- Septal splint folds
- Firm, yet flexible silicone
- Available to order individually or as kit

Kit includes:

- 2 Silicone septal splints (400561)
- 2 Merocel™ nasal packs

Product	Description	Length	Thickness	Height	Qty
400561	Splint	75 mm	25 mm	1 mm	5 pairs
400562	Kit				5 kits



All dimensions are approximate.

# Splints

## Simple splint

- Simple, inexpensive fluoroplastic splint
- Easily trimmed to fit

Product	Length	Thickness	Height	Qty
1522000	2.75"	0.02"	1.75"	10 pairs
	7 cm	0.5 cm	4.4 cm	



## Thermasplints

Product	Description	Qty
1529000	Small	10
1529010	Medium	10
1529020	Large	10

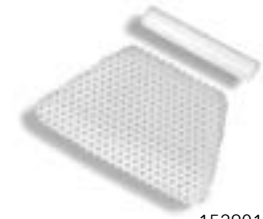

1529010

All dimensions are approximate.

# Septal buttons

## Nasal septal button

- Medical silicone construction

Product	Diameter	Qty
1524105	3 cm	1



## Two-Part adjustable septal button

- For non-surgical closure of nasal septal perforations
- Two-part button
- Medical silicone construction

Designed by Manning Goldsmith, III, MD, Savannah, GA

Product	Diameter	Qty
1524110	3 cm	1



*All dimensions are approximate.*

## Other products

### Instrument wipes

- Removes fluid and debris from delicate instruments

Product	Description	Qty
2218525	3.5" x 3.5" (8.9 cm x 8.9 cm)	25



### Medtronic ENT silicone sheeting

- Sheets are made of biocompatible silicone elastomer
- Sheets can be cut and trimmed as needed during procedures

Product	Thickness	Qty
1532500	5 cm x 5 cm x .25 mm (2" x 2" x .010")	10
1532505	5 cm x 5 cm x .13 mm (2" x 2" x .005")	10
1532510	5 cm x 5 cm x .5 mm (2" x 2" x .020")	10
1532520	5 cm x 5 cm x 1 mm (2" x 2" x .040")	10
1532530	5 cm x 5 cm x 1.6 mm (2" x 2" x .062")	10
1532540	5 cm x 5 cm x 3.2 mm (2" x 2" x .125")	10

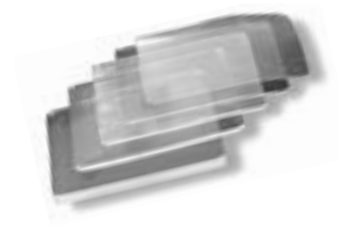

### Micro-grid silicone metric ruler

- Metric scale background
- Radiopaque medical grade silicone
- Sterile

Product	Description	Qty
4022800	Green, 30 mm x 15 mm x 0.4 mm with 1 mm squares	10
4022805	Blue, 30 mm x 15 mm x 0.4 mm with 1 mm squares	10



### Silicone strip

- For use as an implant material to aid in surgical repairs and augmentation in ENT and reconstructive head and neck surgery
- May be cut and trimmed during procedures to size needed (A, B, C, or D)
- Non-sterile

Product	A	B	C	D	Qty
1532600	4.5 mm	9 mm	20 mm	12.5 mm	

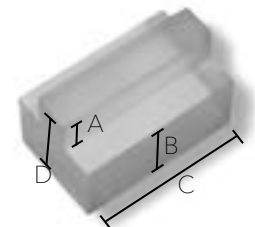

All dimensions are approximate.

Rx only. Refer to product instruction manual/package insert for instructions, warnings, precautions and contraindications.

For further information, please call Medtronic ENT at 800-874-5797 or consult Medtronic's website at **medtronicent.com**.

# Medtronic

## ENT

6743 Southpoint Drive N  
Jacksonville, FL 32216  
USA  
Toll free: 800-874-5797  
Telephone: 904-296-9600  
Fax: 800-678-3995

©2023 Medtronic. All rights reserved. Medtronic, Medtronic logo, and Engineering the extraordinary are trademarks of Medtronic. Third-party brands are trademarks of their respective owners. All other brands are trademarks of a Medtronic company. MPM-12501 Rev 2.0